

Paladin PL18 EV

User Manual

2.4GHz
AFHDS 3

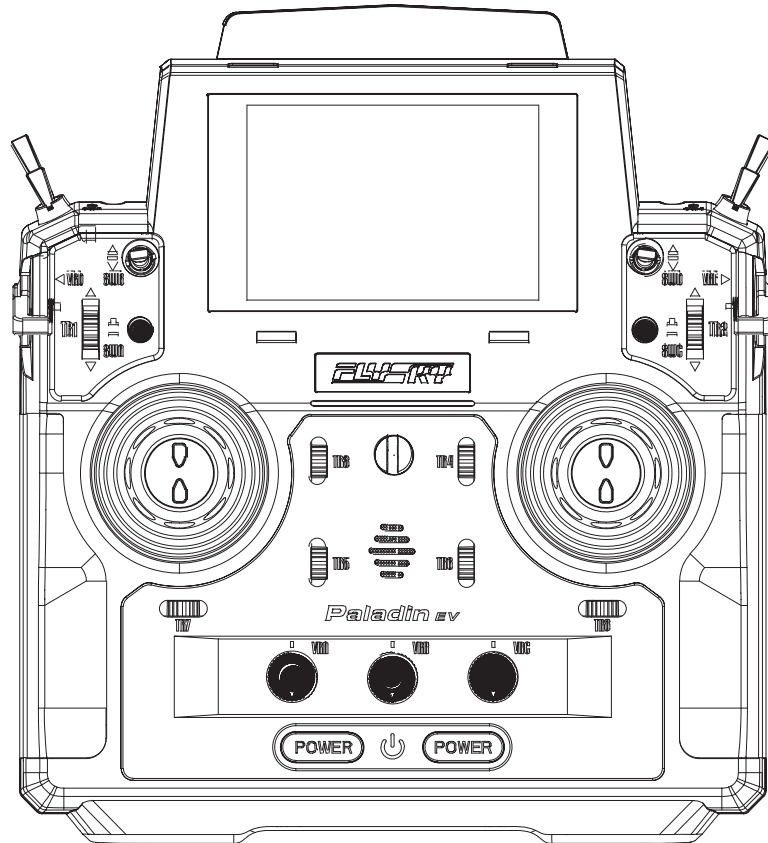

FLYSKY

Touching Infinity

Copyright ©2022 Flysky Technology co., Ltd



15+

WARNING:

This product is only for 15 years old or above.



微信公众号



Bilibili



Website



Facebook



Thank you for purchasing our products. Read the manual carefully to ensure your personal safety as well as the safety of your equipment.

If you encounter any problems during using, please refer to this manual first. If the problem is still not resolved, please contact the local dealer directly or contact the customer service staff via the website below:

<http://www.flysky-cn.com>

Table of Contents



1. Safety	1	7.4.1 Bind Setting	21
1.1 Safety Icons	1	7.4.2 Custom Port Protocol.....	21
1.2 Safety Guide	1	7.4.3 Failsafe.....	21
2. Battery Safety Instructions	2	7.4.4 Range Test.....	22
3. Product Description	3	7.4.5 PWM Frequency	23
3.1 System Features.....	3	7.4.6 Low Signal Voice Alarm.....	24
3.2 Transmitter Overview	4	7.4.7 Low Voltage Voice Alarm	24
3.2.1 Transmitter Antenna	6	7.4.8 BVD Voltage Calibration.....	25
3.2.2 Status Indicator.....	6	7.4.9 Config RX as a PWM Converter.....	26
3.2.3 Stick/Knob/Button/Trim.....	7	7.4.10 i-BUS Setting	27
3.2.4 Adjustment of Multiplex Stick Assembly.....	7	7.4.11 Servo Midpoint.....	27
3.2.5 Power Switches	8	7.4.12 Receiver Update.....	28
3.2.6 Charging Modes	8	7.4.13 About Receiver	28
3.3 Receiver Overview(Take FGr12B as an example)	9	7.5 Sensors	29
3.3.1 Receiver Antenna	9	7.5.1 Display Sensor.....	29
3.3.2 Status Indicator	9	7.5.2 Choose Sensors.....	30
3.3.3 Interfaces	9	7.5.3 Air Pressure Sensor.....	33
4. Pre-operation Setup	10	7.6 Reverse	33
4.1 Receiver and Servo Installation	10	7.7 Endpoint	33
5. Operation Guidelines	11	7.8 Subtrim	34
5.1 Power On	11	7.9 Conditions	34
5.2 Binding	11	7.10 Trims	35
5.3 Pre-operation Checks	13	7.11 Func. Rate(AFR)	35
5.4 Power Off.....	13	7.12 DR Setup	36
6. UI	14	7.13 Channels Offset	36
6.1 UI Overview	14	7.14 Channels Delay	37
6.2 Menu UI.....	15	7.15 Pro. Mixes	37
6.2.1 Function Icons.....	15	7.16 Track Mixing	39
7. Function Settings	16	7.17 A.B.S.	39
7.1 Disp servos	16	7.18 Timers	41
7.2 Function Assignment.....	16	7.18.1 Timers 1/2.....	41
7.3 Model Setting	18	7.18.2 Model Timer	42
7.3.1 Model Name	18	7.18.3 Sound Prompt.....	42
7.3.2 Switch Model	19	7.19 Throttle Curve	42
7.3.3 Model Structure	19	7.20 Logic Switches	43
7.3.4 Model Combination.....	19	7.21 RF Setup	44
7.3.5 Custom Main Menu.....	20	7.21.1 Transmit.....	44
7.3.6 Restore the Current Model	20	7.21.2 RF Set to Be On By Default	44
7.3.7 Copy Model.....	20	7.21.3 RF Alarm Settings.....	44
7.3.8 Import or Export Model.....	20	7.21.4 RF Type.....	45
7.4 RX Setup	21	7.21.5 PPM Setup.....	45

7.21.6 RF Firmware Updating.....	46	7.22.13 TX Firmware Update.....	50
7.22 System	46	7.22.14 About Paladin EV	50
7.22.1 Language.....	46	7.23 Hlep Center	51
7.22.2 Units.....	46	8. Product Specifications	52
7.22.3 Sound	47	8.1 Transmitter Specifications (PL18 EV).....	52
7.22.4 Vibration.....	47	8.2 Receiver Specifications (FGr12B)	53
7.22.5 Backlight Timeout.....	47	9. Package Contents.....	54
7.22.6 Backlight Brightness	48	10. Certification	55
7.22.7 Standby Timeout.....	48	10.1 DoC	55
7.22.8 Auto Shutdown	48	10.2 CE Warning	55
7.22.9 Screen Quick Access.....	49	10.3 Appendix 1 FCC Statement	55
7.22.10 Switch Setting	49	11. Environmentally friendly disposal.....	56
7.22.11 Calibration	49		
7.22.12 Factory Reset.....	50		

1. Safety

1.1 Safety Icons

Pay attention to the following icons and their meanings. Failure to follow these guidelines can result in equipment damage or personal injury.

 WARNING	• Not following these instructions may lead to minor injuries.
 CAUTION	• Not following these instructions may lead to major injuries.
 DANGER	• Not following these instructions may lead to serious injuries or death.

1.2 Safety Guide



Prohibited



Mandatory



- Do not fly at night or in bad weather like rain or thunderstorm. It can cause erratic operation or loss of control.
- Do not use the product when the visibility is limited.
- Do not use the product on rainy or snowy days. Should any type of moisture (water or snow) enter any component of the system, erratic operation and loss of control may occur.
- Interference could cause loss of control. To ensure the safety of you and others, do not operate in the following places:
 - Near any site where other radio control activity may occur.
 - Near high voltage power lines or communication broadcasting antennas.
 - Near water with passenger boats nearby.
 - Near high voltage wires or communication/broadcast antennas.
- Do not use this product if you are tired, uncomfortable or when using substances that may impair your ability to use the product safely.
- The 2.4GHz frequency band requires line of sight from the transmitter to receiver at all times. Avoid large obstacles that could block or interfere with the signal.
- In order to ensure good signal quality, do not hold the transmitters antenna during use.
- Parts of the model, such as motors or ESC's may remain hot for a period of time after use and can cause severe burns.



- Improper use of this product may lead to serious injury or death to the user and others. To ensure the safety of yourself and others read and follow the instructions set out in the user manual.
- To avoid damage to the model, make sure that the product and model are installed correctly before use.
- Always power off the receiver before the transmitter. Powering off the receiver before the transmitter could lead to loss of control.
- Before use make sure that all the servos and motors are moving in the correct direction.
- Make sure to remain within range to prevent loss of control.



微信公众号



Bilibili



Website





Facebook

2. Battery Safety Instructions

Danger

 This products battery is rechargeable and non-removable. Do not remove the battery from the product.

 Do not expose the battery to liquids.
■ Do not use a damp battery. Keep your hands dry during use and do not leave batteries in areas with lots of moisture.

 Do not solder, repair, modify or disassemble the battery.

 Do not charge the battery in direct sunlight, in a hot car or near anything hot such as cookers etc.

 Do not use near flammable liquids or gasses.

WARNING

 Do not touch the charger or battery during charging.
■ May cause burns

 Keep the battery away from any heat source if it is leaking or causing strange smells.
■ May catch fire or explode.

 Do not store the battery in dusty or humid environments.
■ Remove dust from the power connector before plugging in.

 Do not charge batteries that show any evidence of damage, aging, leakage or exposure to liquids.

 Do not touch the positive and negative terminals of the battery together.

 Do not throw the battery into a fire.

 Do not charge without ventilation.

 Charge before use.
■ Failure to charge the battery before use may lead to a crash.

 Do not throw or impact the battery.
■ May cause fire or an explosion.

 Put some tape on the battery's terminals before recycling.
■ If the short circuit causes fire, heat, rupture, etc.

 Do not charger the battery when exposed to extreme heat or cold.
■ May lead to a drop in battery performance. To ensure maximum performance always charge the battery within the temperature range of 10°C ~30°C .



3. Product Description

PL18EV is an 18-channel transmitter dedicated to engineering vehicles, equipped with 2.4GHz AFHDS 3 (third-generation automatic frequency hopping digital system).

3.1 System Features

AFHDS3 (third-generation automatic frequency hopping digital system) is a newly developed digital wireless system. It is compatible with single antenna bidirectional real-time data packet transmission and transparent transmission of data streams. With the advantages that come with the WS2A wireless system and the new 2.4GHz chip, the system can dynamically set: number of channels, channel resolution, range, anti-interference requirements and latency to meet the needs of different users.

Single Antenna Bidirectional Real-time Data Transmission	The system supports one-way and two-way connections. When the transmitter is working in one-way transmission way, the receiver can receive data from the transmitter. When the transmitter is working in two-way transmission way, the receiver can receive data from the transmitter and the transmitter can also receive data from the receiver, as well as the information cross from the temperature and speed sensor modules.
Transparent Transmission of Data Streams	The independent data transparent transmission module is built into RF system, which can realize data transmission via transmitter and transparent transmission. It can be used for data transmission of flight control.
Intelligent RF configuration	Depending on hardware, certification, the amount of data to be transmitted, anti-interference, latency and distance requirements, the system intelligently adapts the corresponding RF configuration to meet the requirements of the user.
Multi-channel Frequency Hopping	This system's bandwidth ranges from 2.402GHz to 2.480GHz. This band is divided into 140 channels. Each transmitter hops between 16 channels (32 for Japanese and Korean versions) in order to reduce interference from other transmitters.
Unique ID Recognition System	Each transmitter and receiver has its own unique ID. Once the transmitter and receiver have been bound, they will save each other's ID and only connect with each other. When the system is working, if the IDs are matched with each other, then the connection will be established; otherwise, there is no connection between transmitter and receiver. This unique ID recognition system resists interference so as to make the system more stable and reliable.
Low Power Consumption	The system is built using highly sensitive low power consumption components, maintaining high receiver sensitivity, while consuming as little as one-tenth the power of a standard FM system, dramatically extending battery life.



微信公众号



Bilibili



Website



Facebook

3.2 Transmitter Overview

Front View

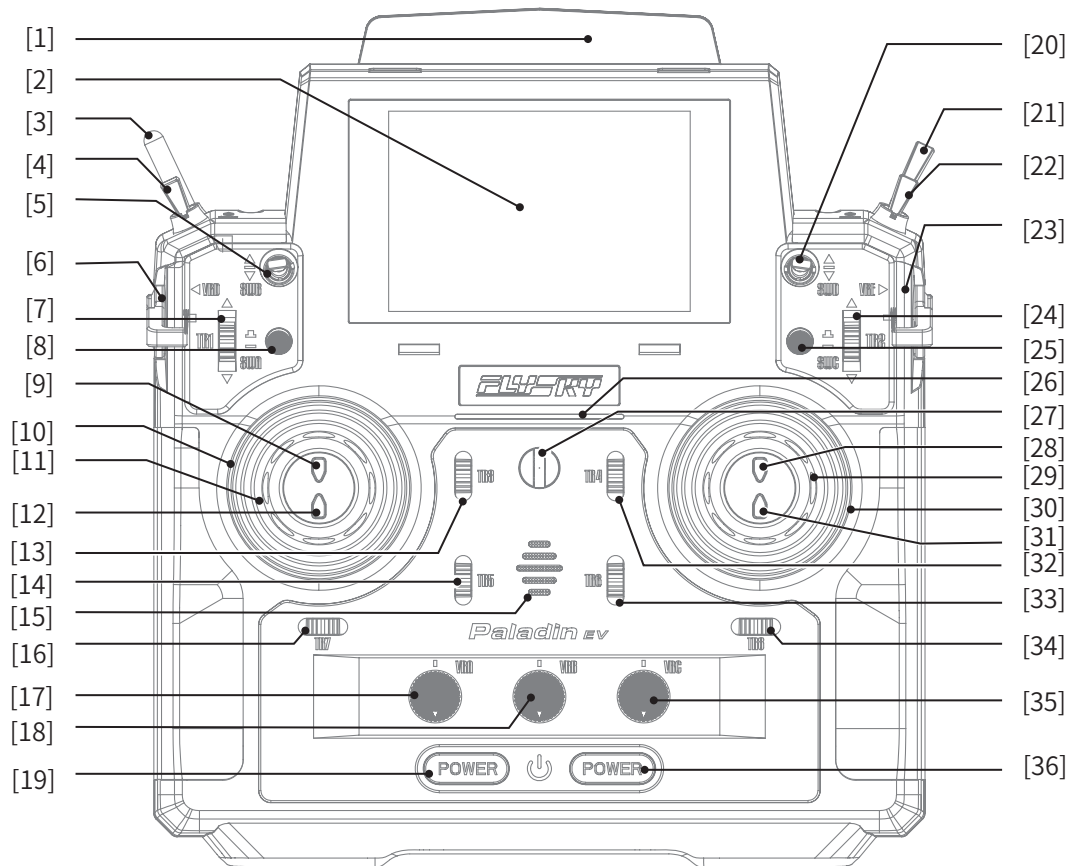

[1]	Antenna	[13]	TR3 Trim	[25]	SWC Self-locking button
[2]	Screen	[14]	TR5 Trim	[26]	Transmitter Status Indicator
[3]	SWF Switch	[15]	Speaker	[27]	Lanyard Eye
[4]	SWE Switch	[16]	TR7 Trim	[28]	SWL Button
[5]	SWB Switch	[17]	VRA Knob	[29]	VRG Knob
[6]	VRD lever	[18]	VRB Knob	[30]	Right Stick
[7]	TR1 Trim	[19]	Power Switch	[31]	SWK Button
[8]	SWA Self-locking button	[20]	SWD switch	[32]	TR4 Trim
[9]	SWJ Button	[21]	SWH Switch	[33]	TR6 Trim
[10]	Left Stick	[22]	SWG Switch	[34]	TR8 Trim
[11]	VRF Knob	[23]	VRE lever	[35]	VRC Knob
[12]	SWI Button	[24]	TR2 Trim	[36]	Power Switch



Back View

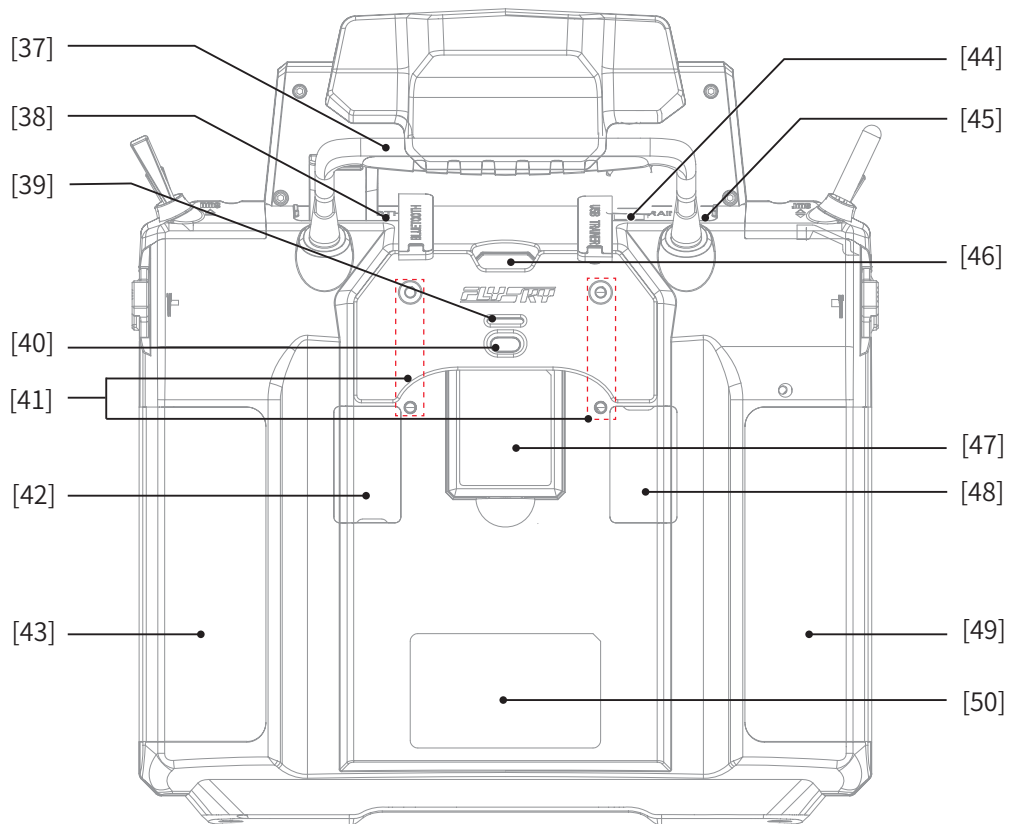

- | | |
|--|--|
| [37] Carry Handle | [44] Micro USB interface |
| [38] Bluetooth Module Interface | [45] Trainer Interface |
| [39] FRM301 Status Indicator | [46] Press to Release FRM301 |
| [40] FRM301 Button | [47] FRM301 RF Module |
| [41] Screw Holes For Fixing RF Module Adapter | [48] Gimbal Tension Adjustment/Stick Mode Switching Adjustment |
| [42] Gimble Tension Adjustment/Stick Mode Switching Adjustment | [49] Grip |
| [43] Grip | [50] Wireless Charging Input Area |



微信公众号



Bilibili



Website



Facebook

Reset button

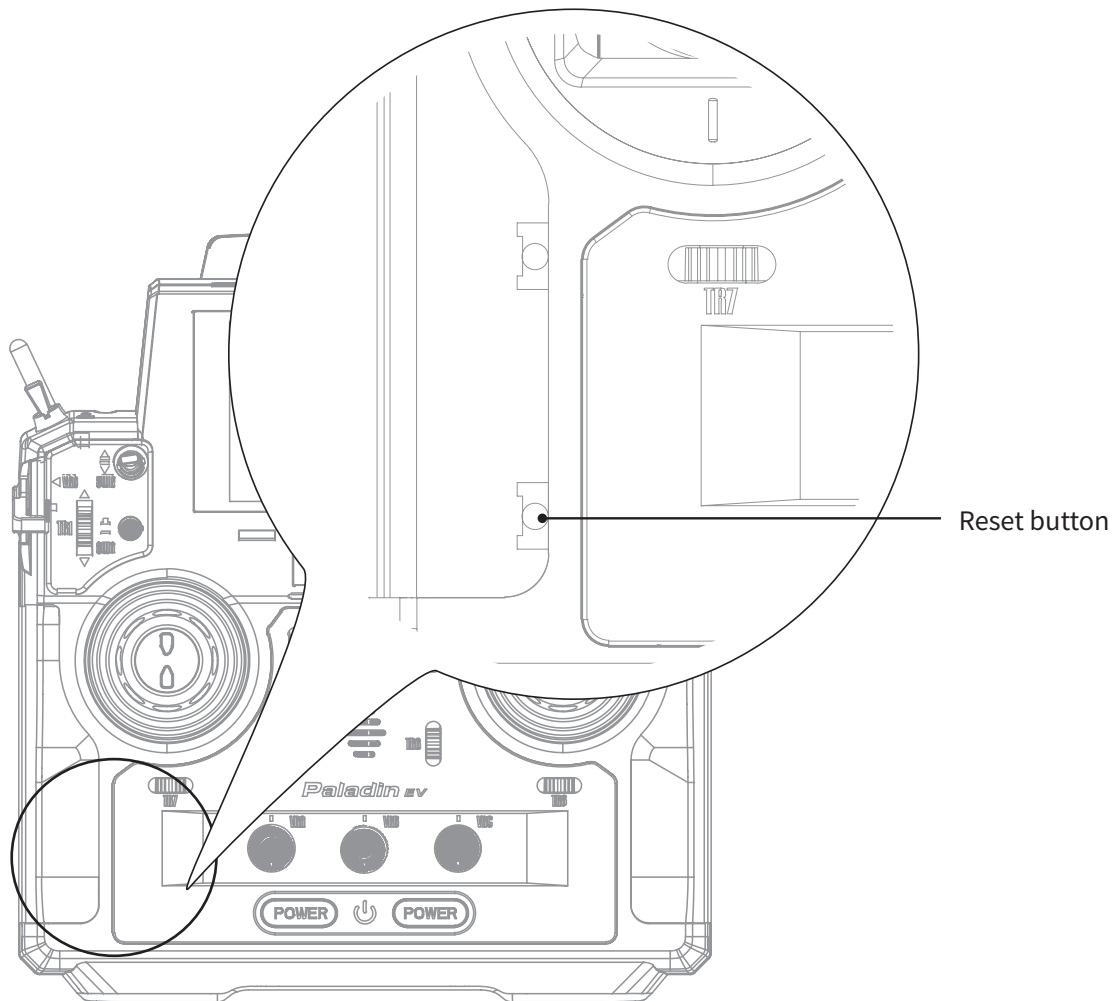

The reset button is on the lower part of the transmitter as shown above. You need to tear apart the grip to find it. To press it by using a long thin tool, such as a smaller screwdriver.

In case of the transmitter can not be powered off by pressing the two Power Switches, please reset the transmitter with the Reset button.



CAUTION

• After resetting, the settings which set before resetting may be invalid.

3.2.1 Transmitter Antenna

PL18 EV transmitter has built-in dual antenna. When the transmitter starts the work, the antenna operates automatically, without additional operations.



ATTENTION

• To ensure a good signal do not cover or block the antenna.

3.2.2 Status Indicator

The status indicator displays the transmitter's power and operating status. Please note the LED lights up in three



states: gradual light, flashing, and solid on.

When the screen is on:

- If RF is enabled without connecting the receiver (one-way binding with the receiver), the blue indicator is solid on.
- If RF is disabled, the yellow indicator is solid on.
- If the receiver is connected in two-way, the green indicator is solid on.

When the screen is off:

1. If RF is enabled without connecting the receiver (one-way binding with the receiver), the gradual light can change to cyan, magenta, and yellow.
2. If RF is disabled, the gradual light is yellow.
3. If the receiver is connected in two-way, the gradual indicator can change to red, green, and blue.
 - The LED is flashing fast in green, indicating that the binding is in progress.
 - The LED is flashing in red, indicating that there is an alarm.
 - The LED is blues: The transmitter is powered on until it starts successfully.
 - In case of power-off: The current color is not changed until the transmitter is shut down successfully and the LED is off.

3.2.3 Stick/Knob/Button/Trim

The PL18 EV has 2 sticks (Left stick and right stick), 6 switches (SWB, SWD, SWE, SWF, SWG and SWH) , 7 knobs (VRA to VRG), 2 Self-locking buttons (SWA and SWC), 4 buttons (SWL、SWI、SWJ、SWK) and 8 trims (TR1 toTR8).

Sticks: Output different value when it is in different position, they can output continuous signal. And they can be used as function controls.

Switches: There are two-position switches and three-position switches. Different value is corresponding to different position. They can be used as function controls, as well as switches to turn on/off the function.

Knobs: The knobs can implement the same function as sticks. Part of them can be used as trim controls.

Buttons: The buttons can implement the same function as switches.

Trims: Output different value when toggling up/down. They can be used as function controls, refer to the chapter about Trim for detailed.

3.2.4 Adjustment of Stick Assembly

Used to adjust the screws on the back of the transmitter, gimbal stick can be either self-centering or non self-centering, as well as changing stick tension/friction.

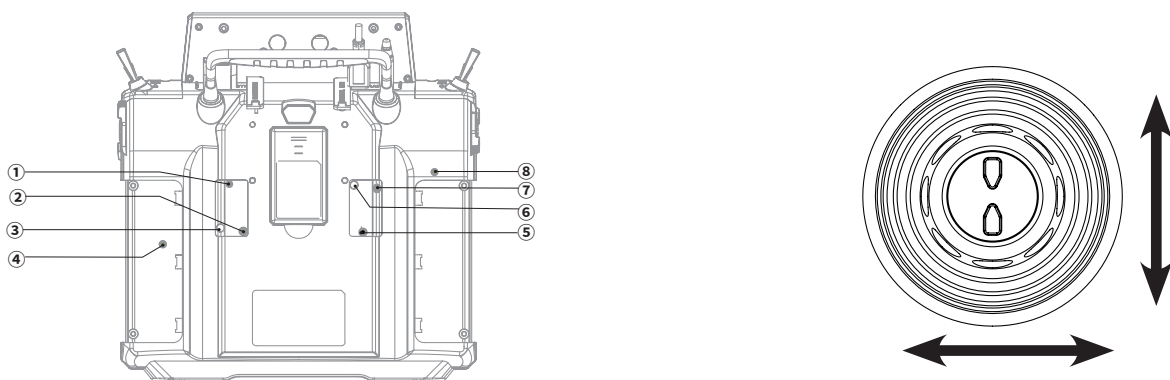

Multiplex Stick Assembly Front View

Stick



微信公众号



Bilibili



Website



Facebook

Function Settings:

By adjusting the tension screws on the back of the transmitter, gimbal stick can be either self-centering or non self-centering, as well as changing stick tension preference.

Available options:	① . ⑤	To change the gimbal sticks self-centering or non self-centering.	② . ⑥	To change vertical tension strength of the gimbal sticks.
	③ . ⑦	To change horizontal tension strength of the gimbal sticks.	④ . ⑧	To change the vertical friction strength of the gimbal sticks.

⚠ CAUTION	<ul style="list-style-type: none"> When the counterclockwise adjustment is made, the entire range of movement of the screw is about 6 circles(the tightest to the loosest). Be cautious not to adjust it too far or the screw will fall out.
-----------	---

Take the right gimbal as example:

- Non Self-centering to Self-centering**
1. Use a Phillips screwdriver to adjust the screw ① counterclockwise until the gimbal reaches its center point.
 2. Adjust screw ④ counterclockwise to adjust the frictional strength.
 3. If you need to adjust the strength of the return, adjust screw ② to change the strength of return to the median position, and to strengthen the strength clockwise, otherwise it's to reduce.

- Self-centering to Non self-centering**
1. Use a Phillips screwdriver to adjust the screw ① clockwise so that the gimbal is no longer at its center point.
 2. Adjust the screw ④ clockwise to strengthen or reduce the frictional strength.
 3. If you need to adjust the strength of the return, adjust screw ② to to change the strength of return to the median position, and to strengthen the strength clockwise, otherwise it's to reduce.

3.2.5 Power Switches

To prevent false triggering, there are two switches on the lower part of the transmitter. Turn on or turn off the transmitter when both switches are pressed at the same time.

3.2.6 Charging Modes

PL18 EV can be charged in two ways:

1. Plug the micro USB cable into the charging port for charging.
2. Use the wireless charging dock to charge it (as shown in the figure)

Notes:

1. Charge it within the safe range [4h@5V*2A/7h@5V*2A (wireless charging)]. Overcharging may lead to battery damage;
2. To prolong the service life of the battery, properly discharge if you want to store it for a long time (that is, not fully charged). In addition, you need to charge it regularly to prevent damage due to not-operation for long term, and charge it regularly to prevent over-discharging damage during storage; It is recommended that the lithium battery be charged to 40-50% of its capacity for preservation. For example, it is recommended that the storage voltage of lithium battery is 3.85V in case of preservation. You need to check the voltage value of the battery every 3~6 months. If it is lower than 3.85V, please recharge it until the battery reaches the said voltage value before representation. Please use the standard charging cable of this transmitter. Improper use may cause damage to the battery and affect its service life.

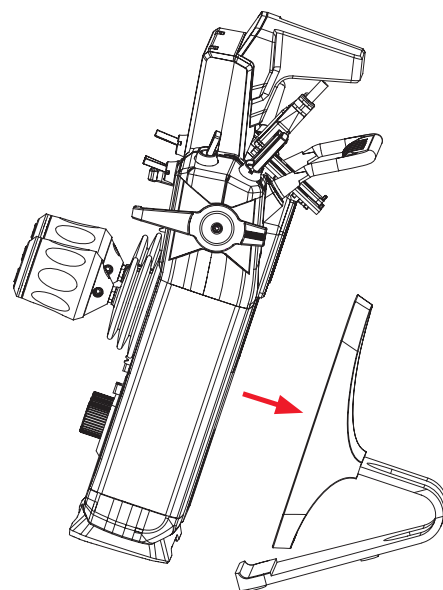

⚠ ATTENTION	<ul style="list-style-type: none"> Please use the standard charging cable of this transmitter. Improper use may cause damage to the battery and affect its service life.
-------------	---



3.3 Receiver Overview(Take FGR12B as an example)

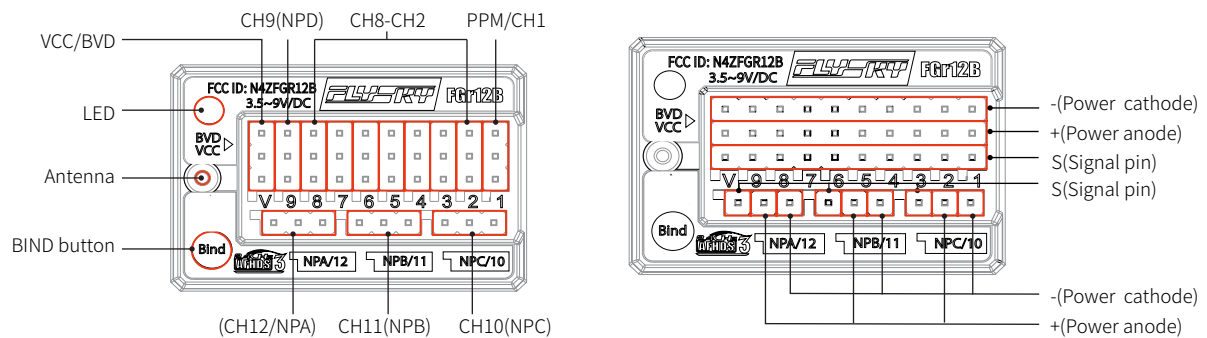

3.3.1 Receiver Antenna

The FGR12B uses AFHDS 3 (third generation automatic frequency hopping digital system), which enables bi-directional transmission.

	CAUTION	• Do not pull, or tie the receivers antenna with the cables connected to servos.
	CAUTION	• Keep the receivers antenna away from conductive materials such as carbon or metal. To ensure normal function make sure there is a gap of at least 1cm between the antenna and the conductive material.

3.3.2 Status Indicator

The LED(status indicator) is used to indicate the power and operating status of the receiver.

- Off: The receiver power is not connected.
- Solid on in red: The receiver is connected to the power supply and is working properly.
- Fast flashing: The receiver is in binding mode.
- Slow flashing: The transmitter which the receiver is bound is powered off, the signal is lost or the receiver firmware is updating.

3.3.3 Interfaces

These interfaces are used to connect the various components of the model to the receiver.

- PPM/CH1: Used to connect the servo, or output the PPM signal.
- CH1 - CH12: Can be connected to the servo, power supply or other components.
- BVD/VCC: Used to detect the battery voltage and connect the power cable.
- Bind button: Used to realize the bind between receiver and transmitter.
- Newport interfaces(NPA~NPD): Supports PWM/PPM/i-BUS signal.

Note: For this transmitter matched with the receiver, see the matching table on the official website. For specific operation mode matched with other receivers, refer to the above contents.



微信公众号



Bilibili



Website



Facebook

4. Pre-operation Setup

Follow the instructions and guidelines in this chapter before use.

4.1 Receiver and Servo Installation

Make sure that the receiver is mounted in an appropriate location within the model, to ensure a stable signal, maximum range and to mitigate external interference, follow these guidelines:

Pay attention to the following when installing the receiver:

1. Make sure the receiver is not installed near ESCs or other sources of electrical noise.
2. Keep the receivers antenna away from conductive materials, such as carbon or metal. To ensure normal function, make sure there is a gap of at least 1cm between the antenna and the conductive material.



ATTENTION

- **To prevent damage, do not power on the receiver during installation.**



5. Operation Guidelines

Follow these guidelines to set up the transmitter and the receiver.

5.1 Power On

Follow the steps below to power on:

1. Check to make sure the receiver is installed correctly and that the receiver is powered off.
2. Press and hold both Power Switches until the screen lights up.
3. Power on the receiver.

ATTENTION • The system is now active, be cautious to not cause damage or personal injury.

5.2 Binding

Note: This function is available for version 1.0.28 or above.

The transmitter and the receiver have been pre-bound at the factory. If you need to rebind or bind a new receiver follow the steps below. The Flysky AFHDS 3 receivers are consisted by classic version receivers and enhanced version receivers. The bind method is slightly different between these two versions.

Note: Flysky AFHDS 3 classic version receiver models: FT10/FG4/FG4s/FG4p/FT4/FT16S. Other Flysky AFHDS 3 receivers are enhanced version receivers.

WARNING

- Power off the servo while the transmitter and the receiver is binding. Otherwise it may lead to danger.
- After the binding process is finished, power off the receiver, then power on the receiver and check to make sure that the transmitter and the receiver have bound successfully.

Tap , then access Binding setting via RX setup.

The binding interface of classic receiver:

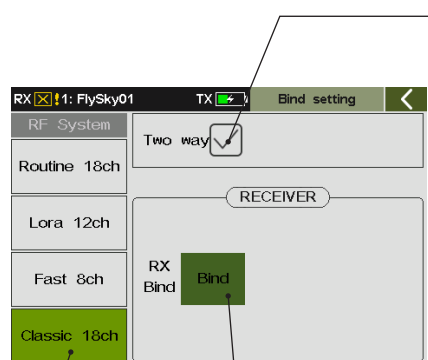

To set the transmitter and the receiver to connect in one-way or two-way. If the ✓ appears, indicating that the transmitter and the receiver are connected in two-way.

Note: When you choose one-way communication, the receiver does not send the data to the transmitter, the LED flashes slowly after the receiver receives the binding information. Then manually put the transmitter to exit the bindig mode. When the receiver LED is solid on, it indicates that the binding is finished.

To bind with classic version receivers. After clicking Bind, a menu prompt of compatible with the receivers will be popped up.

Click Bind to put the transmitter into binding mode. After that a menu will pop up which is showing the binding process.



微信公众号



Bilibili



Website



Facebook

The binding interface of enhanced receiver:

To bind with enhance version receiver and provides 18 channels with moderate communication distance.

To bind with enhance version receiver and provides 12 channels with super anti-interference and moderate communication distance.

To bind with enhance version receiver and provides 8 channels, fast communication within short distance.

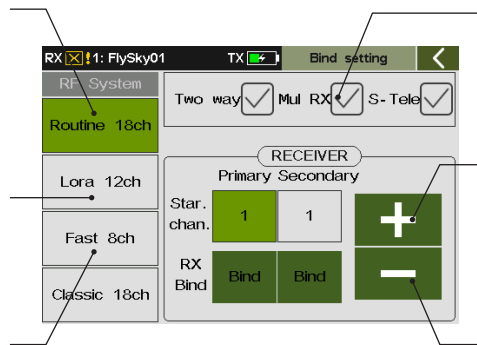

To set multi-RX, the ✓ appears, indicating that the transmitter is in the multiple receivers mode.

To set the starting channel, namely to increase the value.

To set the starting channel, namely to decrease the value.

The binding interface of multiple receivers:

To set the starting channel of the primary receiver.

To bind the transmitter with the primary receiver. Click it to put the transmitter into bind mode.

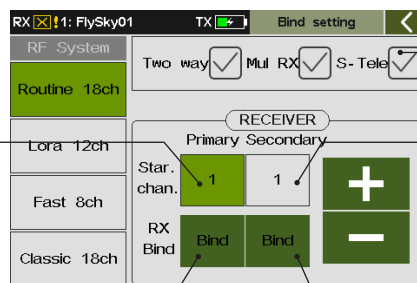

To set S-Tele, the ✓ appears, indicating that the transmitter is in S-Tele mode.

To set the starting channel of the secondary receiver.

To bind the transmitter with the secondary receiver. Click it to put the transmitter into bind mode.

Function Settings:

1. Tap , then select Bind setting via RX SETUP.
2. Tap Bind setting to enter the binding setting interface. Then set some items, such as selecting suitable RF System, choosing two way or not, multiple receiver or S-Tele, setting the starting channel. Afterwards, click Bind to put the transmitter into bind mode.
3. Put the receiver into bind mode.
4. The LED of the receiver stops flashing and is solid on, indicating that the binding process is finished.
5. Check to make sure the transmitter and the receiver are working correctly, repeat steps 1 to 3 (binding process) if any problems arise.

Notes:

1. The receiver may vary with different models, visit FLYSKY official website for more details.
2. When you select Routine 18ch, with choosing Two way connection and Mul RX(Multi-receiver), the transmitter supports multi-receiver mode. In this mode, to ensure the accuracy of the data returned from the primary receiver, bind the primary receiver only.
 - The secondary receiver can bind with multiple receivers. In binding of multiple secondary receivers, the receiver does not return information like one way connection.
 - If S-Tele(Secondary Telemetry) is selected, only one secondary receiver is supported; the secondary receiver only returns its own information.



微信公众号



Bilibili



Website





Facebook

5.3 Pre-operation Checks

Always perform the following steps before each operating:

1. Inspect the entire system to make sure that everything is working as expected.
2. Perform a range test as outlined in the Range Test section of this manual.

 DANGER	• Do not use the model if there are any abnormal behaviors during the test.
 DANGER	• Do not exceed the maximum rated range during use.
 CAUTION	• Interference from other transmitting devices may reduce signal quality.

5.4 Power Off

Follow these steps to power off the system:

1. Power off the receiver.
2. Press and hold both Power Switches of the transmitters at the same time, then the shutdown interface is displayed, prompting "Shutting down...Please wait!". The system will shut down automatically after data are saved.

 DANGER	• To avoid any risk of losing control of the model, always power off the receiver before powering off the transmitter.
--	---



微信公众号



Bilibili



Website



Facebook

6. UI

This is an introduction to the transmitter's UI.

6.1 UI Overview

The main interface displays information related to the model such as sensor information and function status.

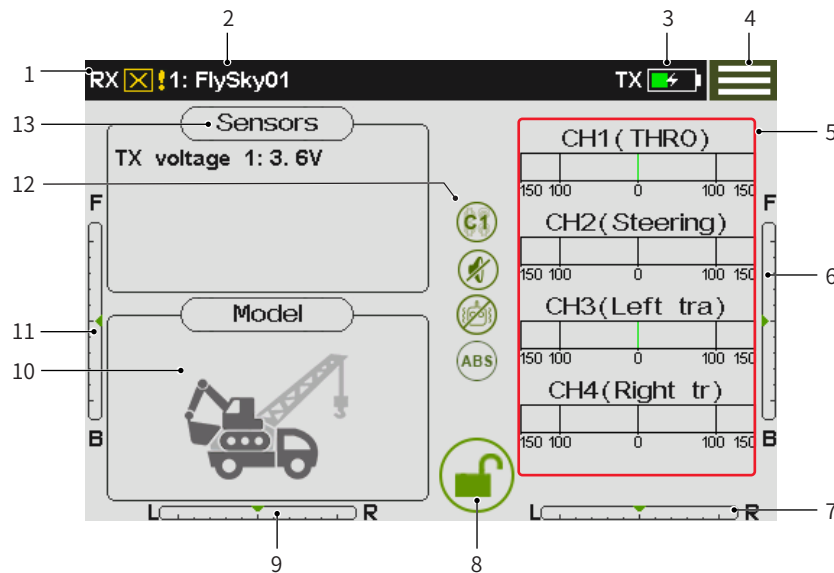

1. Displays signal strength, the receiver is not connected, or the RF is disabled.



Display signal strength, when a receiver is connected in two-way.



The RF module is enabled, but the receiver is not connected.



The RF module is disabled.



The transmitter has bound with the receiver in one-way mode.

2. Model name

Currently selected model's number and name

3. Transmitter power status



Charging



Battery is full.



Low voltage

4. Function menu icon

Tap this icon to enter the function menu.

5. Channel display

Tap this area to access Select disp chan. menu.

6. TR6 trim

TR6 is assigned, the information can be viewed here.

7. TR8 trim

8. Lock screen icon

Tap this icon to lock the screen, then tap and hold this icon for 1 second to unlock the screen.

9. TR7 trim

10. Model type

Tap this area to quickly access the Models setting menu.

11. TR5 trim

12. Status Bar

The icons displayed here indicate that the corresponding functions are activated.



Condition



A.B.S.



Sound



Logic switches



Vibration

13. Sensors











Tap this area to access Display sensors menu.



6.2 Menu UI

This section is a quick introduction on how to use the UI.

6.2.1 Function Icons

	Screen/Function is Locked		Screen/Function is unlocked.
	Function is disabled.		Function is activated.
	Restore to the default setting.		To increase the value.
	Assign switches		To decrease the value.
	For all operating modes.		For current operating mode.



微信公众号



Bilibili



Website



Facebook

7. Function Settings

This chapter introduces the main system functions.

7.1 Disp servos

To display the real-time output value of each individual channel, and activate the mode of testing all 18 channels.

Display Servos

Function Settings:

1. Tap Disp servos to enter the display servos menu.
2. Toggle the control corresponding to the channel.
3. To view the real-time output value via this function.
Tap to return.

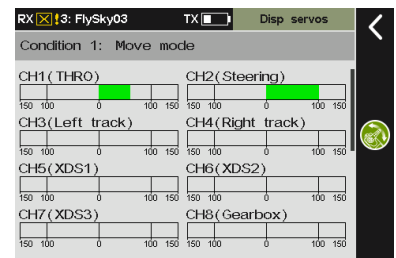

Channel Test

When automatic detection of servos is enabled, servos of all channel will oscillate slowly and repeatedly. Be cautious.

Function Settings:

1. Tap to activate channel test mode. A prompt window appears, then click Yes to start. When test mode is active, all channels will slowly move through their entire range of motion.
2. Tap this icon again to exit test mode.

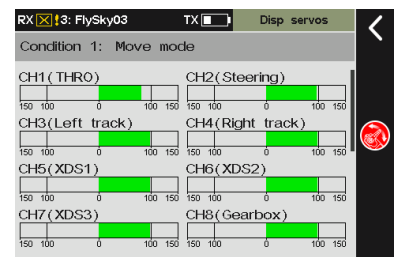

	DANGER	<ul style="list-style-type: none"> • To avoid accidents, do not activate this function when the transmitter is connected with the models or the engines of the model is started.
--	---------------	--

7.2 Function Assignment

This function allows you to reassign the functions, controls and trims of the 18 channels according to the current model structure or operation habits.

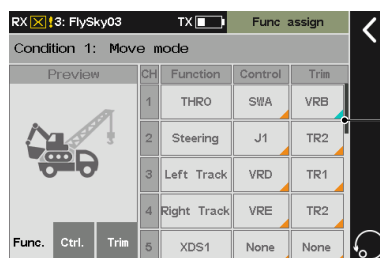

If the small triangle at the bottom right of the function box is cyan, the setting is for all conditions. If it is orange, the setting is for the current condition.



Assigning Function Items

To select a function which need to be assigned a control.

Function Settings:

1. Tap the function that needs to be set and enter the menu.
2. Tap an appropriate function.
3. If you want to create a auxiliary channel for the control, tap Custom:(AUX.1) and enter an appropriate name on the pop-up menu using the soft keyboard. Tap  to return.

Note: Need to set the name of auxiliary channel respectively for different languages.



Control Assign

To assign a specific control for the function selected before.

The controls that can be assigned are **SWA~SWL** switches, **LS1~LS3** logic switches, **J1~J4** sticks, and **VRA~VRG** trim knobs.

Function Settings:

1. Tap the control you want to assign and enter the menu.
2. Tap Control on the menu to finish.

Note: For SW kind switches, you can select it by toggling the corresponding physical switch on the transmitter.

Control Parameters Setting

You can set the related parameters after the control assignment is finished. The parameters are different for different controls.

- For consecutive kind switches, you can select **Normal**, **Reverse**, **High** and **Low**.
Normal/Reverse means that the corresponding control ratio changes from "-100% to 100%" when the control is moved from "down" to "up". It is conversely for Reverse. In other words, When the consecutive switches are moved from "down" to "up", the corresponding control ratio changes from "100% to 100%".

For **High** or **Low**, the control ratio only switches between -100% and 100%, and the middle area is the hysteresis area. Selecting High means the control ratio is 100% in the high position and -100% in the low position. It is conversely for Low.

- For SW kind switches, you can set Normal or Reverse.
 Normal means the control ratio is -100% when the control

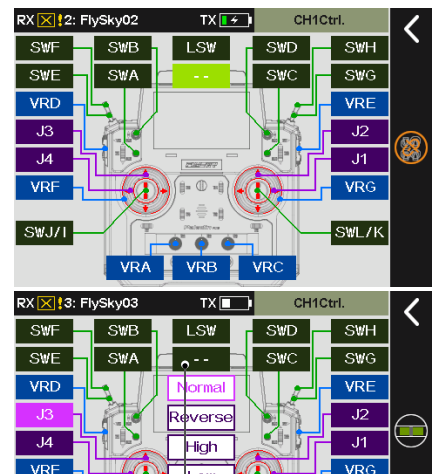

Tap to cancel the control assignment.



微信公众号



Bilibili



Website





Facebook

position is in the low position and 100% when the control position is in the high position (the neutral position control ratio in the three-level switch is 0%).

It is conversely for **Reverse**. In other words, the control ratio of SW switches is 100% in the low position and -100% in the high position.

- For logic switches, you cannot set the parameters. When the logic switch is ON, it means the control ratio is 100% . **OFF** means the control ratio is -100%.

Function Settings:

1. Tap the control, such as VRA, then click Normal or Reverse.
2. Tap High, then tap  to enter the next menu. After selecting Down side or Up side, the selected item turns to light green.
3. Click + or - to change the Up-side and Down-side values to the desired point. Tap  to return.

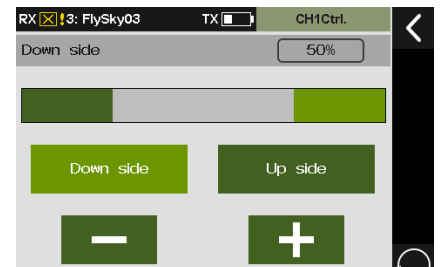

Assigning Function Trims

To assign a trim button for a function selected.

Function Settings:

Enter Trim menu, then tap the trim button on the menu to finish.

Note: For TR kind switches, you can select it by toggling the corresponding physical button on the transmitter.

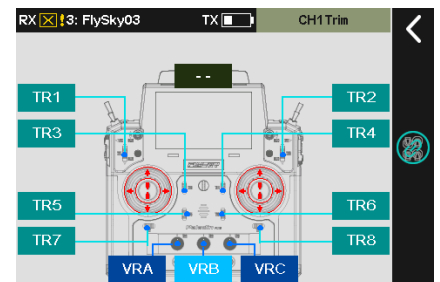

7.3 Model Setting

This function allow you to operate related settings of models, including model name, switch model, model structure, model combination, custom main-menu, restore the current model, copy model, and import or export model.

7.3.1 Model Name

To name the model.

Function Settings:

1. Tap Model name, a soft keyboard comes along with it.
2. Input a new name for it using the soft keyboard. Tap  to return. The length of the model name is limited by the display range of the top status bar.



7.3.2 Switch Model

This function allows you to switch models.

The system can store 20 groups of model data, including all setting data except system settings.

Function Settings:

You can directly select the model to be used in the list, and select Yes in the pop-up dialog box to switch the model.

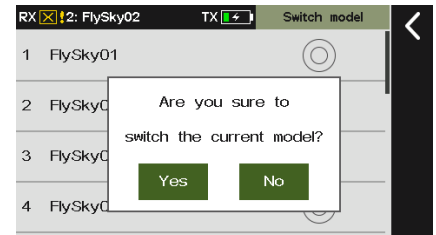

7.3.3 Model Structure

Select the corresponding model structure function for the currently configured model type function. The displayed picture of the model can be changed via this function.

Note: When you modify model structure, the model data is reset.

Function Settings:

Tap the function item you want to set, the ✓ appears, indicating that the item is selected.

Note: Up to 18 function items can be selected.

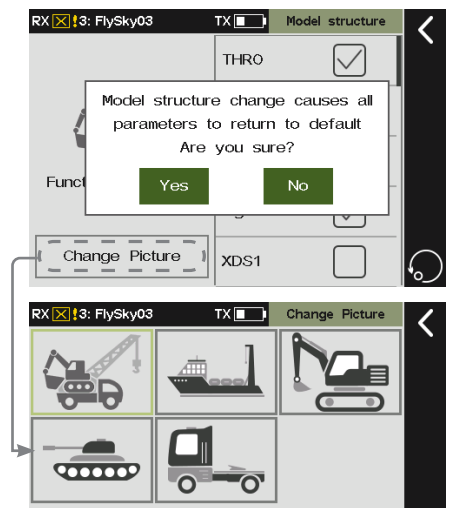

7.3.4 Model Combination

This function allows you to select multi-group of models to establish a model combination and preset a switch. When the model combination contains the current model, at this time, The combined model can be switched by using the presetted switch. Please note that only three-position switch can be presetted, namely the switch is at the up or down position, the model is switched, the middle position is invalid.

Function Settings:

1. Enter the Model combination menu.
2. Tap the models to be combined, click OK in the prompt menu came along with it.
3. Tap to assign a switch, then click to return.

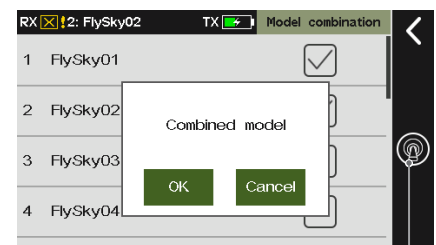

The switch assignment button

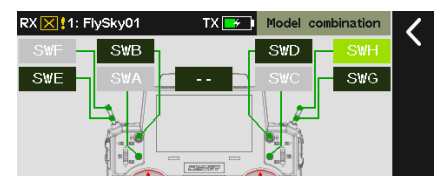

微信公众号



Bilibili



Website



Facebook

7.3.5 Custom Main Menu

You can customize the sorting and hiding functions of the main menu. Click the small box. Select it to display the menu. Deselect it to hide the menu.

Function Settings:

1. Enter the Custom main menu.
2. Select a menu to be moved (highlighted items are selected).
3. Click Move up or Move down to change menu order.



7.3.6 Restore the Current Model

This function allows you to restore corresponding model data to the factory default value (to avoid user's mis-operation, system displays a dialog box for reconfirmation after clicking).

Function Settings:

Click Restore the current model, then click the Yes to finish.

Note: If a receiver has connected to the transmitter, turn off the receiver prior to performing this function.

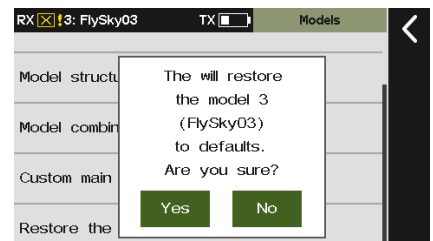

7.3.7 Copy Model

This function allows you to copy the data of one model to another model.

When setting up a new model, you can use this function to copy existing model data and then modify different parts without repeating settings. It is very convenient.

Function Settings:

1. Enter the Copy model menu, then select a model as the copy object.
2. Select the purpose of copying and click Yes in the pop-up window to finish.

Notes:

1. After copying, the model data of the destination will be overwritten by the model data of the copied object.
2. Please be cautious when copying the model, model data can not be restored after it is overwritten.

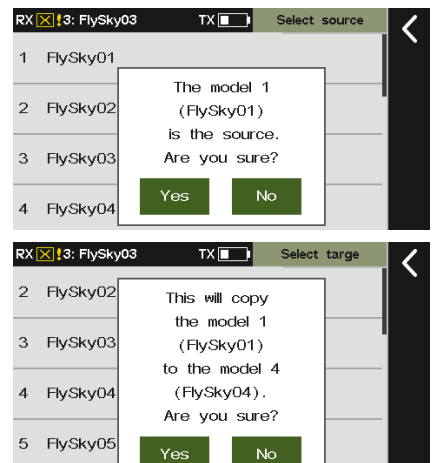

7.3.8 Import or Export Model

To import or export the model.

Function Settings:

Click to import/export the model. You need to log in to the FLYSKY official website to download the software (Flysky Assistant V3.0) and then operate it on a PC!



微信公众号



Bilibili



Website



Facebook

7.4 RX Setup

This section is an introduction to receiver functions.

7.4.1 Bind Setting

Used to let the transmitter into binding state, so as to bind with the receiver.

For specific binding instructions, please refer to 5.2 Binding.

7.4.2 Custom Port Protocol

Sets the type of output signal of the receiver interface. This screen shows on the left side the interfaces that can be set, and on the right side, the protocols that can be set.

Function Settings:

1. Enter the Custom port protocol menu.
2. Click the Newport you want to set, such as NPA. Then click an appropriate protocol.
3. Tap  to return.

Notes:

1. For multi-receiver mode as well as the S-tele is selected, you can set protocol separately for Primary receiver and Secondary receiver.
2. The signal types that can be selected once only in multiple for any Newport: PPM, S.BUS, i-BUS-IN and i-BUS-OUT. If it is selected for NPA, i-BUS-OUT cannot be selected again for NPD, NPC or NPB.
3. For the receivers with SENS interfaces, i-BUS/Servo does not support i-BUS-IN.

The menu of enhanced receivers

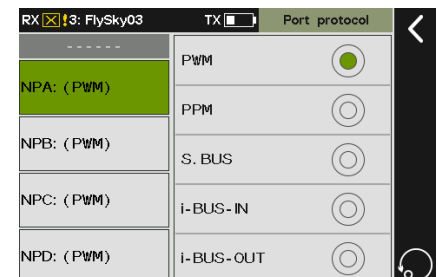

The menu of classic receivers

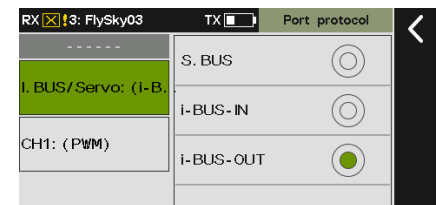

The menu of multi-receiver

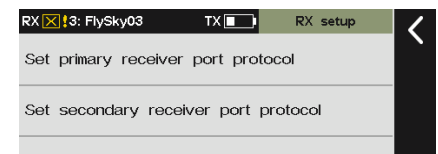

7.4.3 Failsafe

For failsafe function, paladin PL18 EV transmitter provides the following three settings:

- Set to disable the signal output of i-BUS-out and PPM protocol interfaces in case of out-of-control, i.e., no output at i-BUS-out & PPM interfaces in case of losing control.
- Set failsafe values channel by channel: **No output/Fixed value/Hold**.



微信公众号



Bilibili



Website



Facebook

- New Added item: Set Failsafe for all channels set to fixed values. With this function, you can set the output values of all channels controlled by a control to the current value, and this value will be output when the system is losing control.

Set i-BUS-out & PPM to No Output

After the Set i-BUS-out&PPM to no output is enabled, regardless of the setting of the failsafe, these two types of failsafe signals are always no output.

Function Settings:

If the check box next to option is not ticked (), it indicates that the function is disabled.

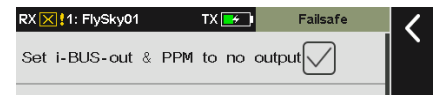

Channel 1~Channel 18

Used to set the output signal states of channels 1~18 respectively: **No output** means the PWM channel interface is no output in case of out-of-control; **Hold** means the last channel value is kept in case of losing control; **Fixed value** means the configured channel value is output in case of outof-control.

Function Settings:

1. Tap the channel and enter the next level menu.
2. Tap to select the desired function options. If the fixed value is selected, turn the Stick(Switch, Knob or LSW) to the desired position and hold it, and click to return. The settings are finished.

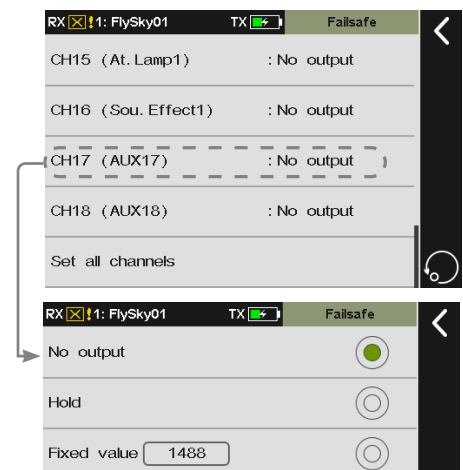

Set All Fixed Value Channels

Used to set the output value of all channels controlled by a control that has been set to a fixed value after out-of-control.

Function Settings:

Tap this function while holding the control, after that a prompt menu comes along with it. Click Yes to finish.

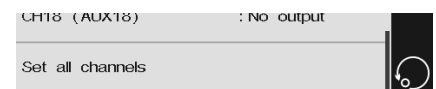

7.4.4 Range Test

This function is used to test whether the transmitter and receiver RF are working properly. As the actual remote control distance between the transmitter



and receiver is far, in practice, it is difficult to pull the transmitter and receiver far enough away to verify whether the RF is normal. Therefore, when this function is enabled, it can test whether the transmitter and receiver are normal at a close distance. Test time is saved.

Function Settings:

1. Make sure the transmitter and receiver are bound.
2. When in the Range test menu, press and hold SWH switch.
3. One person stands in place with the transmitter in hand and the other person takes the model and gradually moves away from the transmitter.
4. Keep the transmitter's antenna unobstructed, then make sure that the receiver antenna is at 90 degrees and no interference between the transmitter and the receiver.
5. Observe the signal strength of the transmitter. If the signal strength is high and stable, it means that RF is functioning normally.

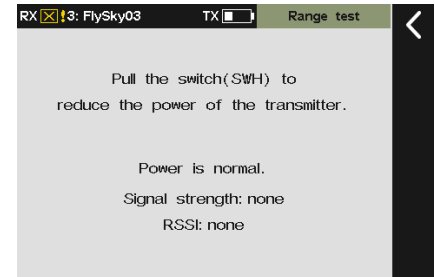

7.4.5 PWM Frequency

The receiver's output frequency of PWM signals can be regulated. Theoretically, the higher the frequency, the faster the signal is refreshed, and the faster the servo responds to the signal change. However, some servos may not support PWM signals with excessively high frequency. You may need to take into account the servo's performance when doing such settings.

The interface of this function may vary with bind modes. For enhanced receivers, the PWM frequency of each channel can be set separately, and the options include analog servo (50Hz), Digital servo (333 Hz), SR (833 Hz), SFR (1000 Hz) and Custom.

If a classic receiver is bound, all channels are set together, and cannot be set to SR (833 Hz) and SFR (1000 Hz).

 ATTENTION	<ul style="list-style-type: none"> • The conventional PWM frequency is 50-400 Hz. When SR (PWM frequency: 833 Hz) and SFR (PWM frequency: 1000 Hz) are selected, the overall system delay is greatly improved, but the pulse range of PWM signals is changed. Please make sure the servo supports the frequency and the setting is correct. Otherwise the servo may not work properly, or even get damaged.
---	---



微信公众号



Bilibili



Website



Facebook

PWM Frequency-Enhanced Receiver

Set PWM frequency after the transmitter is bound to enhanced receivers.

Set all channels.

Function Settings:

1. Tap Set all channels.
2. Tap an appropriate item according to the actual servo.
3. For Custom, click + / - to set an appropriate frequency value.
4. For Synchronized with RF, click the check box at the right. " ✓ " means the function is activated.

Set a channel, please refer to the description above for function settings.

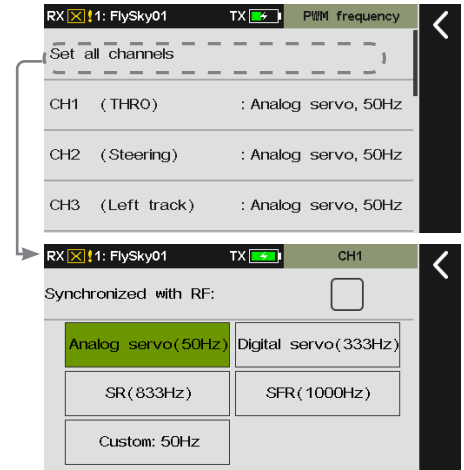

PWM Frequency-Classic Receiver

Set PWM frequency after the transmitter is bound to the classic receivers.

Function Settings:

1. Enter PWM frequency menu.
2. Tap to select the desired function options. Tap to return.

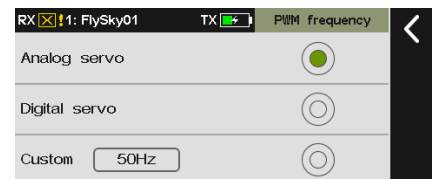

7.4.6 Low Signal Voice Alarm

This function allows you to enable or disable low signal alarm function.

Function Settings:

Click Low signal voice alarm to enable or disable the function.

After selecting this function, when receiver signal strength is less than or equal to 40, the transmitter indicator flashes and an audible alarm is given.

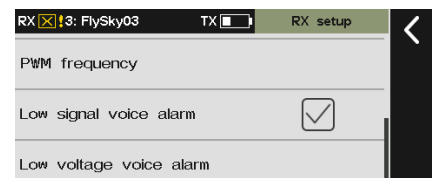

7.4.7 Low Voltage Voice Alarm

Set voltage alarm, battery type, low voltage alarm value and ultra-low voltage alarm value. Once set, the transmitter will trigger a voice alarm if the battery voltage of the relevant device is lower than the set alarm voltage to alert the user of low voltage or ultra-low voltage.



Function Settings:

1. Enter the Low voltage voice menu.
2. Click an appropriate item according to what you want to set. Then click  to return.
3. Tap Battery Type to enter the setting menu, then click an appropriate battery type.
4. Click + / - to set an appropriate voltage according to the actual device.

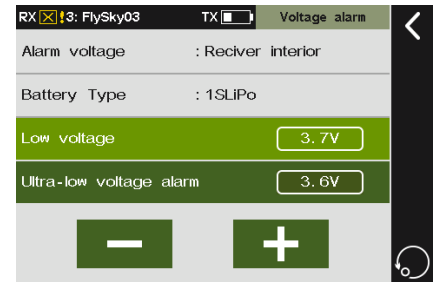

Notes:

1. When it is set to detect the voltage of external sensors, and the receiver is connected to more than one voltage sensor, only the first voltage sensor connected to the receiver is detected for its voltage.
2. If BVD voltage is selected, the receiver needs a BVD interface to detect BVD voltage via BVD detection cable.
3. When multi-receiver is bound, the receiver voltage alarm is set to the primary receiver.

7.4.8 BVD Voltage Calibration

Note: This function is available for version 1.0.28 or above.

There may be a voltage difference between the receiver detection voltage and the actual battery voltage. This function provided the receiver with a calibration factor to narrow the gap between the detected and actual voltages. The calibration factor is stored in the receiver. Set the calibration factors separately when different receivers calibrate the same battery, or the same receiver calibrates different batteries.

Function Settings:

1. Make sure the transmitter and receiver are bound.
2. Connect the BVD harness to the receiver's BVD interface. Make sure the positive and negative terminals are connected to the positive and negative poles of the battery.
3. Tap BVD voltage calibration to enter the setting menu.
4. Click + / - to tune to the measured voltage of the battery.
5. Click Calibrate to start.

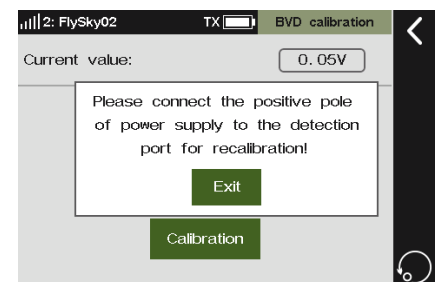

Notes:

1. This function is applicable to enhanced receivers with BVD function.
2. Make sure the battery is properly connected during calibration. To ensure accurate calibration, the Current Value, in calibration, needs to be set to the battery's measured voltage value. Recalibrate if necessary.



微信公众号



Bilibili



Website



Facebook

7.4.9 Config RX as a PWM Converter

Set the receiver as a PWM converter for PWM channel expansion. After the setting is successful, the receiver is used as a PWM converter, and its interfaces output PWM signals.

Function Settings:

1. Enter Set as PWM converter menu.
2. Click + / - to set the slave's Start channel and Frequency, then click Config to start.
3. Put the receiver into binding state, when the receiver LED turns fast flashing to two-falsh-one-off, it indicates that the config is finished, tap  to return.

Notes:

1. The receivers that can be set as a PWM converter are list here: FGr8B, FTr8B, FGr12B, FTr12B, FGr4B, INr6-HS, FGr4 or FTr10.
2. The receiver set as the PWM converter can be converted into a receiver by rebinding the transmitter, and then used normally as a receiver after successfully rebinding the transmitter.

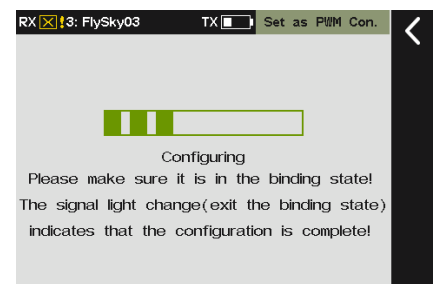
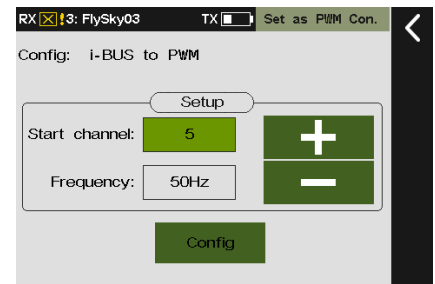

Take FGr12B receiver as a Master receiver and FGr8B receiver as a PWM converter as an example to explain how to set the converter and the connections.

Function Settings:

1. The transmitter and the receiver FGr12B have bound.
2. Set the interface which is going to connect the PWM converter to i-BUS-OUT.
3. Set FGr8B as a PWM converter, please note the start channel number.
4. Connect the NPA interface of the PWM converter to the interface set to i-BUS-OUT of the FGr12B receiver.

Notes:

1. For the classic receivers, after it is set as a PWM converter, its SENS interface is connected to the interface of the receiver outputting i-BUS signal.
2. For the enhanced receivers, after it is set as a PWM converter, its NPA interface is connected to the interface of the receiver outputting i-BUS signal.



7.4.10 i-BUS Setting

This function is used to set the external device with supporting i-BUS protocol, and the Serial Bus Receiver (FS-CEV04) and can be set currently. When using i-BUS serial bus receiver, it recommends to power it separately.

Function Settings:

1. The transmitter and the receiver have bound.
2. Connect the FS-CEV04 to the SERVO port or the Newport set to i-BUS-OUT of the receiver.
3. At the transmitter side, select the channel you want to assign via i-BUS setting, a pop-up prompt window will appear. If the channel is wrong, click Cancel, then select a new one.
4. If the selected channel is about to assign to C1 channel of the Serial Bus Receiver FS-CEV04, then press the button K1 corresponding to C1 channel of FS-CEV04 receiver by the tool shipped with the bind cable.
5. Repeat the steps above for setting more channels.

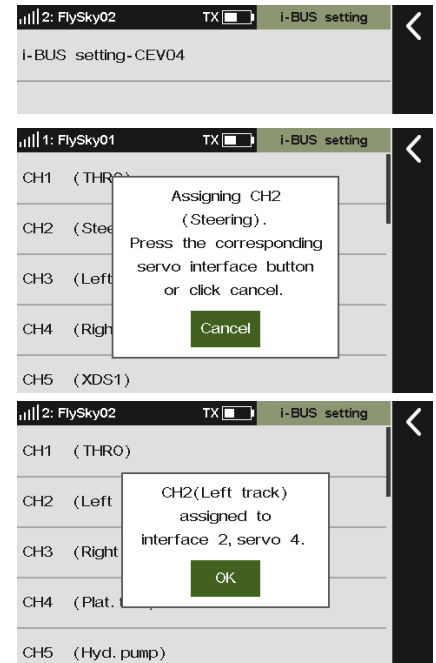

7.4.11 Servo Midpoint

This function sets the value of the servo's midpoint. The default is 1500, which is suitable for most flight control of racing drones. When using standard S.BUS with a device such as the Vbar gyro flight controller it can be set to 1520, to achieve the midpoint offset for all channels.

Function Settings:

1. Enter Midpoint offset menu.
2. Click an appropriate item, tap to return.



微信公众号



Bilibili



Website



Facebook

7.4.12 Receiver Update

To update the firmware of the receiver. PL18 EV transmitter packs the firmware of FGr12B, FGr8B, FTr10, FTr16S, FGr4 and FTr4/FGr4S/FGr4P. It can also be updated via FlyskyAssistant. Please note that this function is applicable for the FlyskyAssistant firmware version 3.0 or above.

Function Settings:

1. The transmitter and the receiver have bound.
2. Tap Receiver Update to enter and select the receiver you want to update.
3. Click Update , then click Yes in the pop-up window to put the receiver into updating mode.

Note: If the receiver firmware is the latest version, the system will display a propted reminder and no need to update.

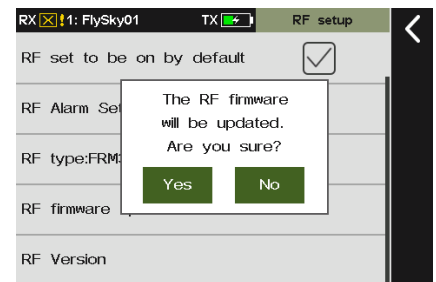

 ATTENTION	<ul style="list-style-type: none">• If the transmitter is unable to bind with the receiver after its firmware is updated, it is required to forced update the firmware of the receiver.
--	--

To put the receiver into forced updating mode first, then follow the steps above to update.

The methods of entering forced mode varied with the models, refer to the manual of the receiver for the detailed.

Take FGr12B receiver as an example, you can put it into forced updating mode by the following two methods.

- Power on the receiver while pressing and holding the BIND button for more than ten seconds, until the LED of the receiver operates in three-flash-one-off manner repeatedly, then release the BIND button.
- Power on the receiver first, then press and hold the BIND button for more than ten seconds, when the LED of the receiver operates in three-flash-one-off manner repeatedly, then release the BIND button.

7.4.13 About Receiver

To view the information of the receiver connected to the transmitter, such as product name, firmware version or receiver ID.

Function Settings:

Tap About receiver and view the information.



7.5 Sensors

This function allows you to set the transmitter, internal receiver and data returned by the external sensor.

7.5.1 Display Sensor

Type	ID	Value
TX voltage	1	3.6V
RX voltage	2	5.1V
Signal strength	2	100
RSSI	2	-28dBm
SNR	2	81dB
Noise	2	-109dBm
BVD voltage	2	0.0V

1. Display the sensor type

- **TX Voltage:** To display the voltage for the transmitter's battery.
- **RX Voltage:** To display the power supply voltage for the receiver.
- **Signal strength:** To display the signal strength between the transmitter and the receiver. It is calculated by using SNR. The signal strength will be displayed as a value between 0 and 100. In the same environment, the farther the distance, the smaller the value. If the signal strength drops to 4 or below, the system will alert the user.
- **RSSI:** To indicate the power of the signal received by the receiver. 0 to -40dBm: Indicates that the distance between transmitter and receiver is close and the communication quality is best. -40dBm to -85dBm: The communication quality is good. Less than -85dBm: Indicates that there is an obstacle between the transmitter and receiver or the distance is far. Please shorten the control distance to avoid losing control.
- **SNR:** The signal-to-noise ratio refers to the decibel difference between the signal and the noise received by the receiver. The signal-to-noise ratio equals the data of RSSI subtract the data of Noise, which is a decisive parameter in the overall quality of the signal. If the SNR

drops below 11, reduce the range quickly to prevent loss of control.

- **Noise:** Noise is generated due to interference from other nearby transmitters such as WIFI. In places where there are too many transmitters, excessive noise will affect the remote-controlled distance.

2. Display sensor's number

- The ID number 1 represents the transmitter
- The ID number 2 represents the receiver or the primary receiver(Multi-receiver connected), and its related information, such as signal strength, RSSI, Noise, or SNR.
- The ID number 4 represents the first external sensor connected to the receiver, and so on. There are up to 15 sensors can be connected.

3. Displays the data returned by a sensor.



微信公众号



Bilibili



Website



Facebook

7.5.2 Choose Sensors

This function is used to set the sensor data displayed on the main interface, and to enable setting the current sensor alarm threshold.

Function Settings:

1. Tap a item from the list and enter its menu.
2. Tap  to enable the alarm function as well as setting a customize alarm value. Click the item you want to set, then it will highlight in light green.
3. Click + or - to set the alarm value.
4. If you want to display the data of external sensors, click Sensor column to enter next level menu, then select an appropriate sensor.

Note: Once any sensor is set, the system will clear the default sensor and sensor data, showing only the current sensor and sensor data.

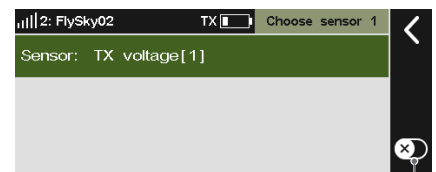
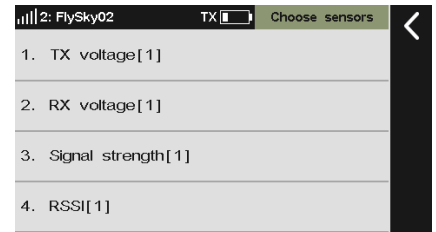

Enable/disable switch.

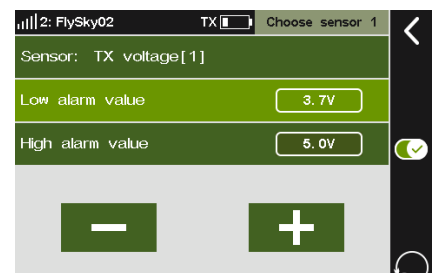

The following descriptions are installations and function settings about some i-BUS sensor modules.

Take the FGr12B receiver and the PL18 EV transmitter as an example, connect the sensor to the NPA interface of the FGr12B receiver, and the other sensor can be connected to the IN interface of this sensor in turns. The connection digram between the sensor and the receiver is shown below.

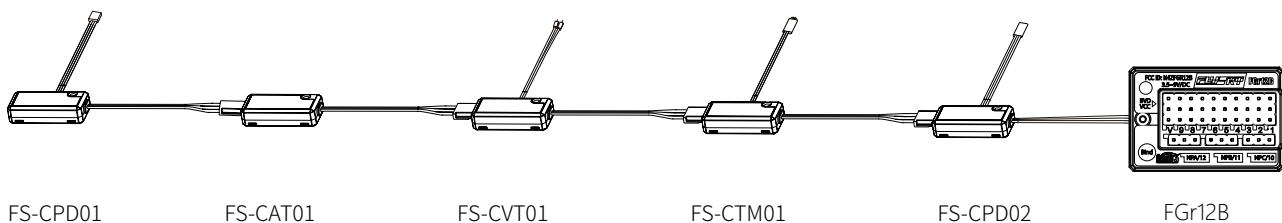

Note:

1. The abbreviations for the Newports are for NPA, NPB, NPC and NPD, the receiver supports up to 4 newports.
2. For classic receivers, connect the sensor to the SENS interface of the receiver.



FS-CPD01: Magnetic induction speed acquisition module

Used to measure the speed of the motor. Connect it to the NPA interface of the receiver directly. Then view the real-time information via **Dispaly sensors** function.

Function Settings:

1. Connect the FS-CPD01 sensor to the NPA interface of the receiver.
2. Place the sensor next to the magnet, which is fixed to the spinning part of a model such as the blades of a plane rotor.

Note: Make sure that the sensor is within 2mm of the magnet and the north pole or south pole of the magnet is parallel to the sensor.

3. At the transmitter side, access **Display sensors** via **Sensors**, if the Motor speed value changes, then the installation is successful, otherwise repeat the above.

Note: Motor speed means the sensor is testing the speed of the motor. 12rpm is the speed measurement value.

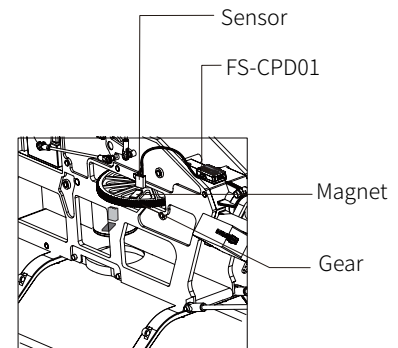

FS-CPD02: Optical Induction Speed Acquisition Module

Used to measure the speed of the motor. Connect it to the NPA interface of the receiver directly. Then view the real-time information via **Dispaly sensors** function.

Function Settings:

1. Connect the FS-CPD02 sensor to the NPA interface of the receiver.
2. Mount the sensor and the reflective sticker to the axial rotation position.

Note: Keep the reflective sticker flat and perpendicular to the sensor, and the distance between the sensor and the sticker is moderate.

3. At the transmitter side, access **Display sensors** via **Sensors**, if the Motor speed value changes, then the installation is successful, otherwise repeat the above.

Note: Motor speed means the sensor is testing the speed of the motor. 12rpm is the speed measurement value.

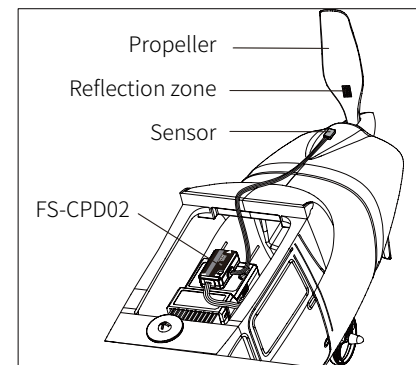

FS-CTM01: Temperature Acquisition Module

This sensor is used to monitor the temperature of a chosen part of the model. Connect it to the NPA interface of the receiver directly. Then view the real-time temperature via **Dispaly sensors** function. You can set the alarm value.



微信公众号



Bilibili



Website



Facebook

Function Settings:

1. Connect the FS-CTM01 sensor to the NPA interface of the receiver.
2. Use soft double-sided tape to attach the FS-CTM01 to element you want to measure (e.g., motor, battery). Make sure the sensor is pressed against the surface snugly.
3. At the transmitter side, access **Display sensors** via **Sensors**, if the temperature is displayed, then the installation is successful, otherwise repeat the above.

Note: Temperature means the sensor is testing the temperature. 26.4° C is the measured value.

FS-CVT01 voltage acquisition module

The FS-CVT01 function is used to monitor the model battery voltage. Connect it to the NPA interface of the receiver directly. You can set the alarm value.

Function Settings:

1. Connect the FS-CVT01 sensor to the NPA interface of the receiver.
2. Insert the red and black wire pins into the port on the battery. Red is positive and black is negative.
3. At the transmitter side, access **Display sensors** via **Sensors**, if the **Ext voltage** is displayed, then the installation is successful, otherwise repeat the above.

Note: Ext voltage means the sensor is testing the voltage. 3.2V is the measured value.

FS-CAT01 altitude pressure module

The FS-CAT01 detects the altitude of the model using air pressure.

Function Settings:

1. Connect the FS-CAT01 sensor to the NPA interface of the receiver.
2. Use double sided soft tape to snugly fix the FS-CAT01 receiver in place.
3. At the transmitter side, access **Display sensors** via **Sensors**, if the **Altitude** is displayed, then the installation is successful, otherwise repeat the above.

Note: Altitude means the sensor is testing the altitude. 133m is the measured value.



7.5.3 Air Pressure Sensor

Calibrates ground pressure.

Function Settings:

1. Connect the FS-CAT01 sensor to the NPA interface of the receiver, then place the model on the ground.
2. Use + or - to adjust the altitude.

Note: Make sure your model is always at a level ground level during setup.

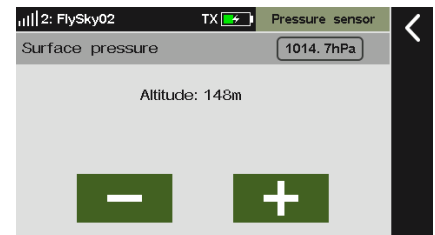

7.6 Reverse

This function reverses the direction of motion for each channel. This function can be used to correct the direction of the servo action which is opposite to the intended operation.

Function Settings:

Touch the box to the right of the channel name to toggle reverse for that channel. If there is a tick in the box it means that the channel is reversed.

Notes:

1. If a new model is connected make sure that all the servos are moving in the right direction.
2. Move each stick to make sure that the control surfaces are moving in the correct directions.

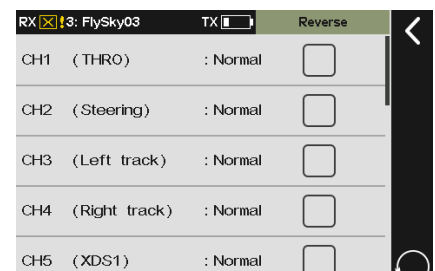

7.7 Endpoint

Changes the max range of movement and the movement range limitation(minimum value, maximum value) for each channel.

End is used to set the max of movement value for the travel range of the servo. **Range** is used to set the limited value for the travel range. After **Range** is set, even if the mixing function increases the travel value of the servo, the servo movement range will not exceed the range value, thus to protect the servo.

When the servo neutral position deviates too much from the position required for the configuration, the position adjustment will not achieve a desired effect by this function. Please adjust the servo neutral position first.

With this function, you can adjust the maximum servo movement of 18 channels respectively.

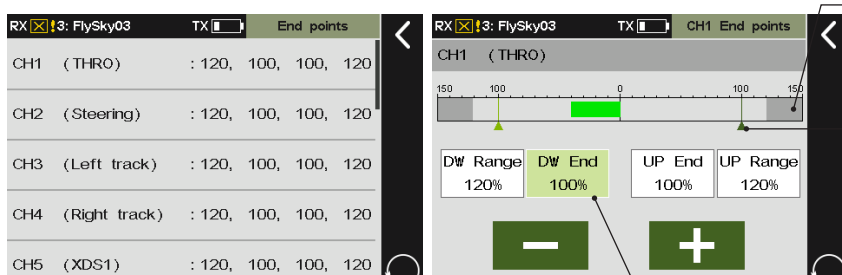

The gray areas are for the set UP and DW(down) ranges.

The green triangles are for the set up and down endpoints.

Tap to select the DW End.



微信公众号



Bilibili



Website



Facebook

Function Settings:

1. Enter End point menu.
2. Tap the item you want to set, then click + / - to change the value. Tap  to return.

7.8 Subtrim

This function is used to adjust the center point of each channel.

Due to the structure of some models the servos center point may need to be adjusted so that when at rest all the control surfaces line up properly.

When using this function make sure that the stick, knob etc. is at its center position.

Function Settings:

1. Enter Subtrim menu.
2. Click the channel you want to set.
3. Click + / - to change the neutral value. Tap  to return.

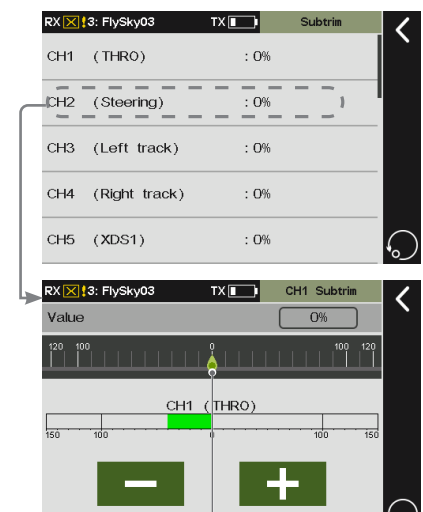

To display the neutral point.

7.9 Conditions

Conditions is divided into move mode and work mode. The two modes can be done with different settings to achieve the same operation in different modes corresponding to different effects. When the same stick is used to control the mobile mode or arm, this function can be used to assign the control mode in two working modes for achieving the menu switch. The title shows the current conditions state. You can set the function parameters to save the current conditions.

Function Settings:

1. Click the working mode.
2. Enable this function, and toggle the corresponding button or switch. Click  to save setting.
3. Toggle the switch to change the work mode.

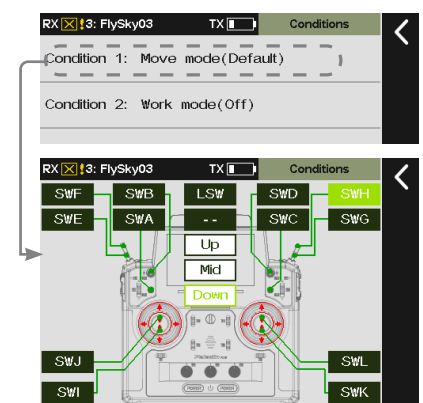

7.10 Trims

You can view the trim values that assigned functions. For TR1 to TR8, you can set the appropriate **Step value**, **Trim mode** and **Trim value**, whether for current condition or all condition. And for VR kind trim, you can only set the Trim mode and Trim rate.

Different trim modes can be selected under different trim buttons, mainly including **Translation** (the trim value is limited by the range of channel travel, the size of the trim value within the range does not change with the channel value), **Center max** (Maximum at the midpoint, positive and negative respectively weakened to the maximum/minimum value of travel when the trim is 0), **High max** (The highest point of travel is the normal value of trim, go to the low end with the trim weakened, the other is similar to horizontal movement), and **Low max** (Opposite of High max).

Function Settings:

1. Enter Trim menu.
2. Toggle the corresponding trim button on the transmitter for adjustment. Toggle the trim key. The current channel change value is the step value. Hold the trim key for seconds to quickly change the value.
3. Adjust until the model posture is balanced. Release the button to finish the adjustment.

Note: This function is mainly used in the process of model operation. Please remember operation steps before you start to use it.

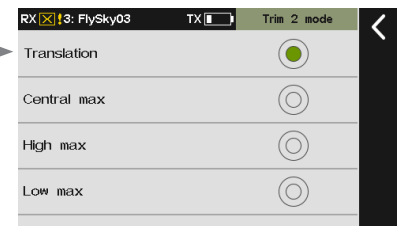
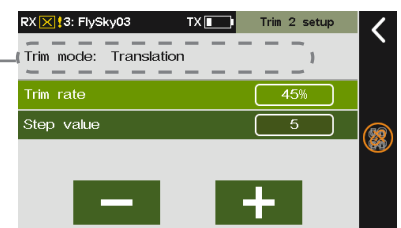
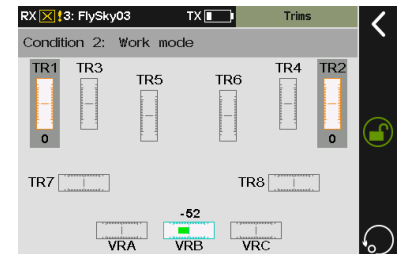

7.11 Func. Rate (AFR)

Note: This function is available for version 1.0.28 or above.

You can set servo volume change curves of all sticks, knobs, and switches assigned to the channel. You can switch to different conditions to set different curves respectively. The servo volume change curve for the conditions controlled by DR is set after enabling the DR. It is recommended that the Func. rate be set after the End point setting is finished. Any mixes source will be applied the Func. rate function.

RateA is the ratio to the left of the neutral, and vice versa for RateB. EXPA is the curve to the left of the neutral, and vice versa for EXPB. Rate A/B and EXPA/B are selected separately or fully depending on the curve type, when the curve type is EXP1, EXP1 can not be adjusted separately although it distinguishes between A and B. When the curve type is EXP2, SYMM (symmetric), the rate and curve are divided into A and B. A and B need to be set in linkage, and cannot be adjusted individually. When the curve type is EXP2, LINE, the rate and curve are divided into A and B, and both A and B can be adjusted separately

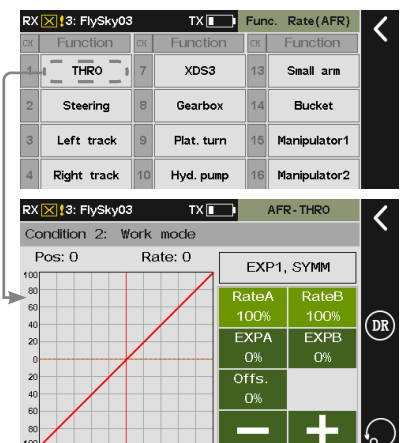

微信公众号



Bilibili



Website



Facebook

Function Settings:

1. Tap the function you want to set.
2. Select EXP2, LINE .
3. Tap the function item you want to set.
4. Click + / - to change to an appropriate value. Tap **↩** to return.

7.12 DR Setup

Note: This function is available for version 1.0.28 or above.

Set the function, switch of DR and effective condition to enable the DR. The transmitter supports 10 groups DR.

Function Settings:

1. Enter DR setting menu.
2. Select a function item you want to set, tap **↩** to return.
3. Tap the box next to function, set an appropriate switch to enable or disable DR function and switch status. Then tap **↩** to return
4. Tap the box corresponding to the mode to enter the setting menu, then select the appropriate mode, tap **↩** to return.

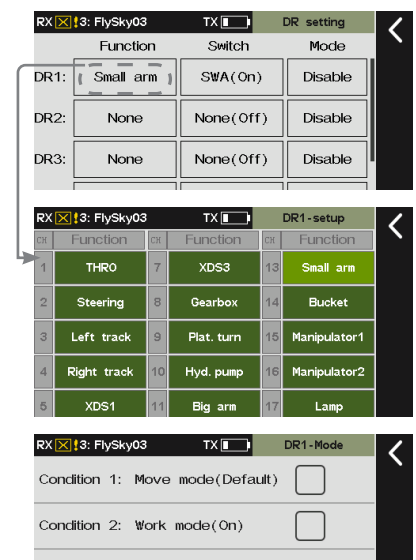

7.13 Channels Offset

This function allows you to adjust the overall offset of each channel data. The offset caused by the model can be corrected using this function. If the offset is set too much, the control amount of one end of the channel is reduced. If the model deviation is large, please try to adjust the model first.

Function Settings:

1. Click the channel you want to set.
2. Click + / - to change to a value, then click **↩** to return.

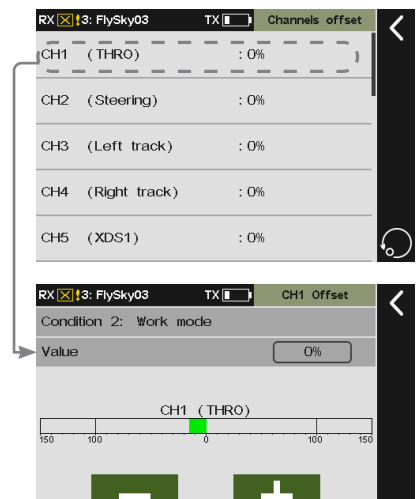

7.14 Channels Delay

This function is generally used to reduce the instantaneous large speed of the servo.

Function Settings:

1. Click the channel you want to set.
2. Click + / - to change the delay time to an appropriate point, then click  to return.

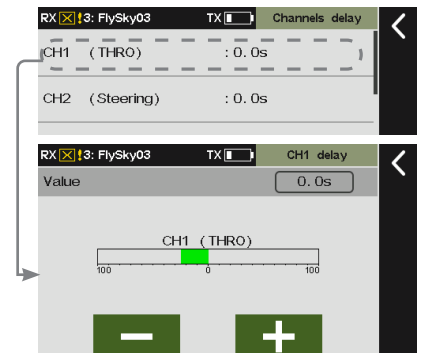

After setting delay, when toggle the control, the menu is as below.

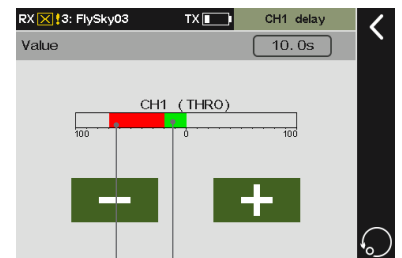

Represents the input value.
Represents the output value.

7.15 Pro. Mixes

A new special control combo can be created to correct the disadvantages of the model. You can select a stick/knob or a function as a Master. When selecting a function, you can set whether the trim affects the Slave. The function can be used to set the servo change of the Master mapping to the Slave channel through a custom curve. You can set a switch to enable/disable the Mix, and set the delay to enable/disable the Mix function.

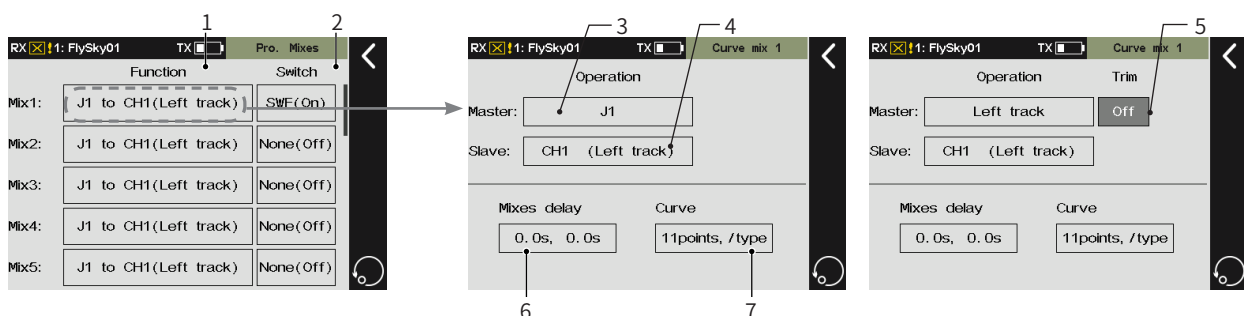

1. Tap to enter the setting menu
2. To assign mixing switch
3. Click to enter the corresponding menu of Master
4. Click to enter the corresponding menu of Slave
5. To turn on or turn off the trim
6. Click to enter the Mixes delay setting menu
7. Click to enter the Curve setting menu



微信公众号



Bilibili



Website



Facebook

Setting Master

Used to set related settings of Master. You can set one control or function as the Master.

Function Settings:

1. Tap the function box next to Master to enter.
2. Tap Stick or Knob to enter if you want to set Master to a control. Tap the desired control or knob you want to set, then click  to return.
3. Tap Func.(function) to enter if you want to set Master to a function. Tap the desired function you want to set.

Note: If a control is set as the Master, then no Trim function.



Setting Master's Trim

Used to set Master's Trim on/off. Please note that only the function is set as a **Master**, the Trim function item will come along.

Function Settings:

Tap the box under the Trim to toggle between On or Off.

Note: When the Mix activates and the trim of the Master is set to On, the trim of Mater will affect its Slave. If the Trim is set to Off, the trim of Master will not affect the Slave.

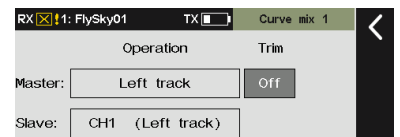

Setting Mixes Delay

Sets the delay time in the current condition from triggering to taking effect for **Open delay** or **Close delay** of the Mix. If the **Mix delay** needs to be set for other conditions, switch to other conditions prior to settings.

Function Settings:

1. Tap Open delay or Close delay.
2. Click + / - to change to an appropriate value, then click  to return.

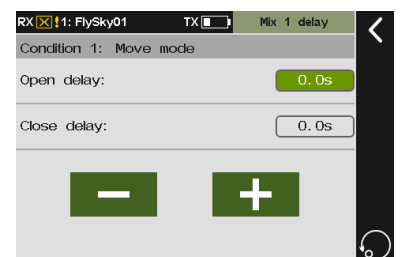

Curve

Used to set the mix rate for the channel in current condition. If the Curve needs to be set for other conditions, switch to other conditions prior to settings.

Function Settings:

1. Enter Curve setting menu.
2. Click Line type to set the appropriate line type.
3. Tap Rate or Offs.
4. Tap « or » to select a dot.
5. Click + / - to change to an appropriate value, then click ◀ to return.

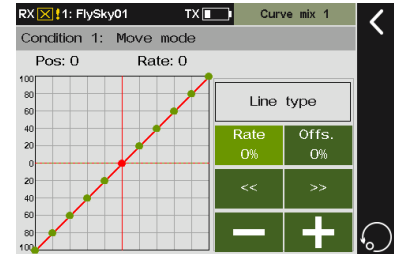

7.16 Track Mixing

In the model structure, select the **Left track** and **Right track** function in **Models**. In the model function menu, the **Track mixing** function is added.

You can control the left and right tracks with one stick to move forward or steer differently at the same time.

Function Settings:

1. Enter Track mixing setting menu.
2. Tap an appropriate item, the selected item is in highlight green.
3. Click + / - to change to an appropriate value, then click ◀ to return.

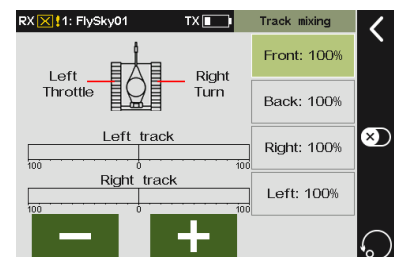

7.17 A.B.S.

Select the THRO(throttle function) in the model structure, and the A.B.S. function is added in the model function menu. This function helps prevent brake lock and improve brake performance by pulse braking, to achieve the best braking effect and cornering control effect without drifting and under-turning. You can also set a switch to turn on or turn off the function.

Return

Used to set the reduction of braking pressure at each pulse between 0% and 100%. The default value is 50%. When the value is set to 60%, the system will reduce the braking



微信公众号



Bilibili



Website



Facebook

pressure by 60% from each pulse in real-time when braking is triggered.

Function Settings:

1. Tap Return.
2. Click + / - to change to an appropriate value.

Delay

To set the time from trigger the pulse brake to actually pulse brake between 0% to 100%. The default value is 0%. The higher the value, the slower the pluse brake function will take effect. When the value is set to 0%, there is no delay, i.e. the pulse brake function takes effect

immediatly when the brake is triggered. When the value is set to 100%, the delay is 2S.

Function Settings:

1. Tap Delay.
2. Click + / - to change to an appropriate value.

Cycle

It is used to set the interval between pulses. The setting range is 20% to 100%. The default value is 50%. The larger the value, the longer the interval time between pulses. The value 100% indicates the interval is 0.5S.

Function Settings:

1. Tap Cycle.
2. Click + / - to change to an appropriate value.

Point

It is used to set the start position of pulse brake function. The setting range is 20% to 100%. The default value is 30%. The higher the value, the closer the stick position that triggers the pulse brake function is to the full brake position. 0%-100% is the entire travel movement amount of the throttle trigger..

Function Settings:

1. Tap Point.
2. Click + / - to change to an appropriate value.

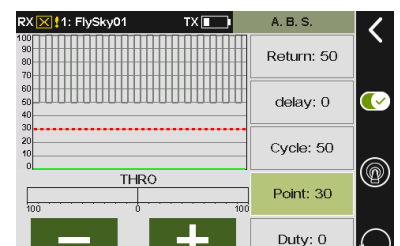
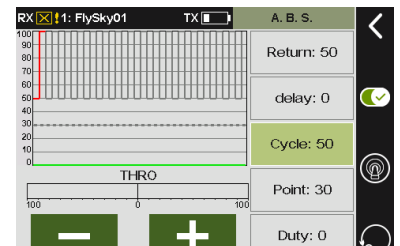
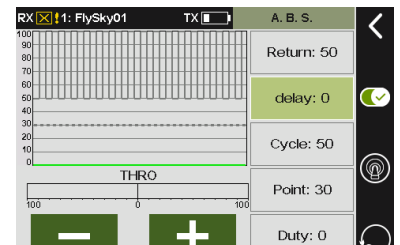
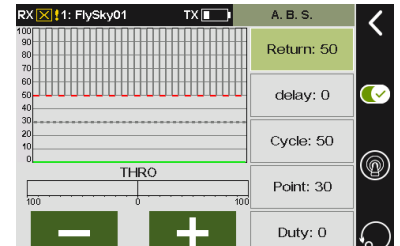

Duty

Used to set the braking to release cycle length in pulse braking between -4 and +4. The default value is 0. When the value is changed, the peak and trough lengths of the brake pulse's square wave change accordingly. You can adjust the rate between braking and release. The rate is 1:1 when the cycle length is set to "0". The rate is 1:2 when the cycle length is set to "1". And the rate is 2:1 when the cycle length is set to "-1".

Function Settings:

1. Tap Duty.
2. Click + / - to change to an appropriate value.

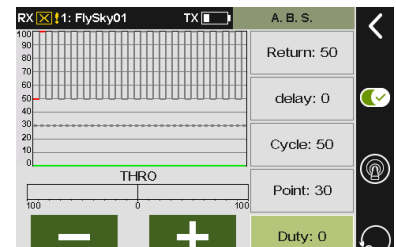

7.18 Timers

This function allows you to set various timers, which are generally used to calculate the total model running time, competition specific time spent or transmitter running time, etc.

7.18.1 Timers 1/2

Timers 1 and Timers 2 have the same function. Only one timer setting method is introduced below.

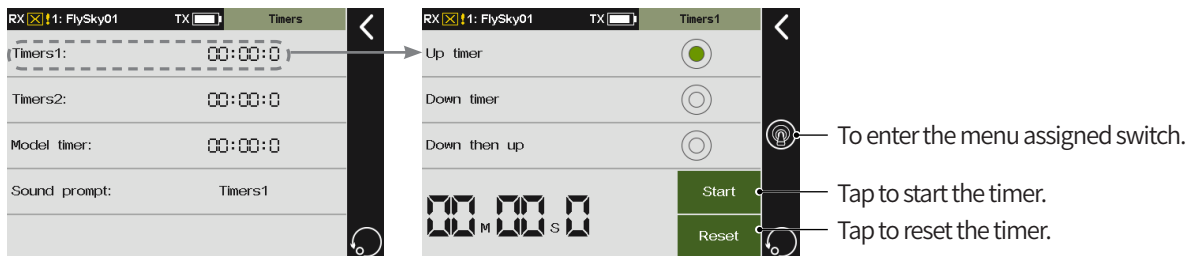

Function Settings:

1. Tap Timer1 to enter.
2. Select timer type.
3. Select Down timer or Down then up, click + / - to set time, the default time is 5 minutes, if Up timer is select, ignore this step.
4. Tap Start to start the timer, and click Stop to stop the timer, to reset the timer, click Reset. You can also click  to assign a switch corresponding to start, stop or reset the timer.



微信公众号



Bilibili



Website



Facebook

7.18.2 Model Timer

Used to calculate total working time of the model.

Function Settings:

1. Tap Model timer to enter, then tap  to activate the function.
2. To reset the accumulated time, click **Reset** to reset the timer.

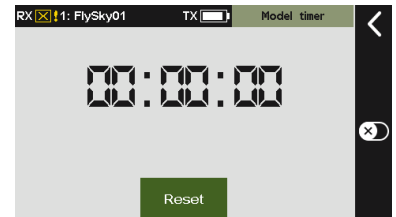

7.18.3 Sound Prompt

This function can be selected according to the needs of the voice prompt Timers 1 or Timers 2.

Function Settings:

1. Enter Sound prompt menu.
2. Tap the item you want to set, then click  to return.

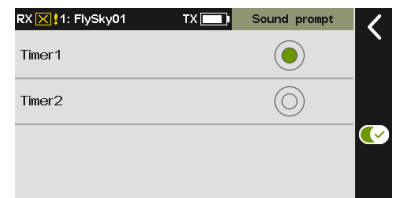

7.19 Throttle Curve

This function changes the output curve for the throttle channel. A curve can be created using 3 – 11 different points so that the user has much better control of the model's engine. The setting is for current condition, for the settings of other conditions, switch to other conditions first, and then carry out the settings.

Function Settings:

1. Enter Throttle curve menu.
2. Tap **Line type** to enter, then select the curve type, after clicking **Yes** to return to the previous menu.
3. Tap **Rate** or **Offs.**
4. Tap **«** or **»** to select a dot.
5. Click **+ / -** to change to an appropriate rate value or offset value, then click  to return.

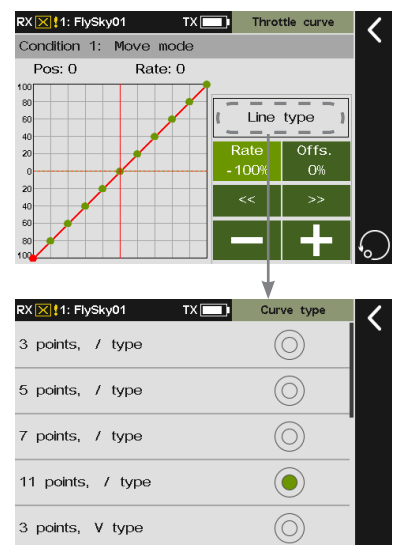

7.20 Logic Switches



This function changes the output curve for the throttle channel. A curve can be created using 3 – 11 different points so that the user has much better control of the model's engine. The setting is for current condition, for the settings of other conditions, switch to other conditions first, and then carry out the settings.

AND If switch 1 and switch 2 are active, then the logic switch will be on. If either switch 1 or switch 2 is off, or switch 1 and switch 2 are both off, the logic switch is off.

OR If either switch 1 or switch 2 is active, or switch 1 and switch 2 are both on, then the logic switch will be on. If switch 1 and switch 2 are both off, the logic switch will be off.

XOR If either switch 1 or switch 2 is active, then the logic switch will be on, but if switch 1 and switch 2 are both active or off, the logic switch will be off.

Function Settings:

1. Enter Logic switches menu.
2. Tap a logic switch to enter.
3. Tap the top Select Sw. to enter, then select a switch and position, click  to return.
4. Tap the down Select Sw. to enter, then select a switch and position, click  to return.
5. Click AND, OR, or XOR according to the following table.
6. Toggle the switches to make sure everything is working as expected.

Refer to the table below for more information on logic gates and their function.

Switch		Gate(Logic switch)		
Switch 1	Switch 2	AND	OR	XOR
OFF	OFF	OFF	OFF	OFF
OFF	ON	OFF	ON	ON
ON	OFF	OFF	ON	ON
ON	ON	ON	ON	OFF

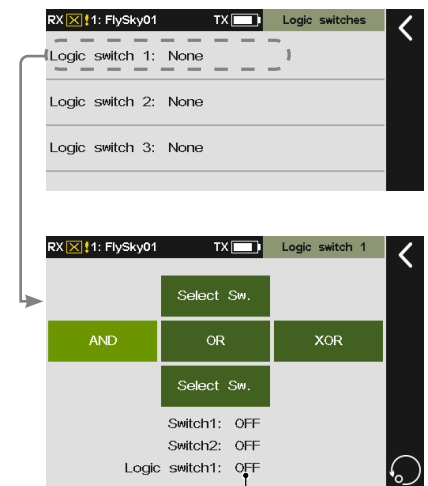

The statuses of the two switches and the logic switch.



微信公众号



Bilibili



Website



Facebook

7.21 RF Setup

Used to set and display some parameters and information related to RF, such as RF type, RF module firmware update, RF module version information related content.

7.21.1 Transmit

Select this option to enable the RF function. By default, it is enabled.

Function Settings:

Tap Transmit, when checked, it means the function is enabled.

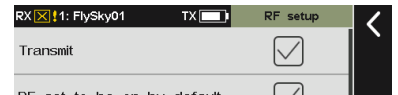

7.21.2 RF Set to Be On By Default

To set the RF function is enabled or disabled.

Function Settings:

Tap RF set to be on by default, when checked, it means the function is enabled.

Note: If this option is not selected, the system displays a message, indicating whether to enable the transmitting function when the transmitter is turned on.

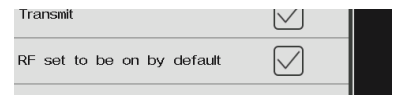

7.21.3 RF Alarm Settings

Note: This function is available for version 1.0.28 or above.

To set the safe status for SW class switches. After setting, when the transmitter powers on, the system will check whether the switch is on the safe position. If the switch is not at the safe position, a alarm will activate.

Function Settings:

1. Enter RF Alarm Settings menu.
2. Tap the box next to the switch to select an appropriate position, then click  to return.



7.21.4 RF Type

Used to select an appropriate RF type as per the communication protocol of the receiver which is bound with the transmitter. FRM301 (classic receiver) and FRM302 (enhanced receiver) are compatible with AFHDS 3 protocol; PPM is for RF module using PPM protocol, and CRSF for RF module using CRSF protocol.

Function Settings:

1. Enter RF Type menu.
2. Tap the RF type you want to set, then click Yes to finish.
Click  to return.

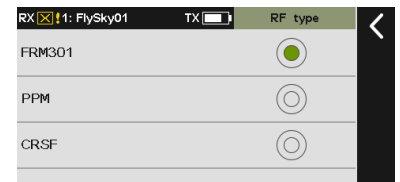

7.21.5 PPM Setup

When PPM is selected for RF type, a PPM setting function appears in the RF setting interface, where you can set the parameters related to PPM signals.

Signal polarity: By default (positive), high-level stands for valid signal. Some devices may require low-level for valid signal. Set the signal polarity to negative, and low-level represents valid signal.

Number of channels: To set the number of channels in one PPM signal. By default, each PPM signal contains 8 channels. You can set the number of channels as required.

Period: The time consumed to send a PPM signal. The period of standard 8-channel PPM signal is 20ms. For fewer channels, you can set shorter periods. As the required time to send a signal is shorter, the delay is reduced. In period setting, you shorten the time of idle periods only, not that of the effective signal. Therefore, setting a shorter period will not reduce the number of signal channels. When the number of channels increases, and the transmission time of effective signals exceeds the period, the system will minimize the idle periods when processing the signals, and the interface setting will not change accordingly.

Starting level: Identifies the start index time of PPM signals. The default value is 400 us. You can set an appropriate value from 100us to 700us as needed.

Function Settings:

1. Tap Signal polarity to select positive or negative.
2. Tap Number of channels, then click + / - to change to an appropriate value.
3. Tap Period, then set an appropriate value by using + / -.

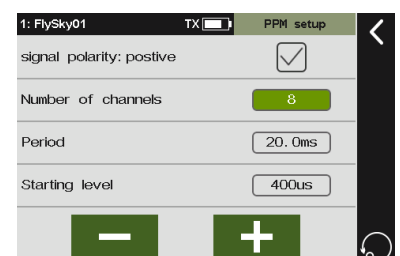

微信公众号



Bilibili



Website



Facebook

4. Tap Starting level, then click + / - to set an appropriate value. Click  to return.

7.21.6 RF Firmware Updating

To upgrade the RF firmware . It is only available when the RF type is set to FRM301.

Function Settings:

1. Click RF firmware updating.
2. Tap Yes in the pop-up window to enter the updating state, the system will exit updating state when the updating is finished.

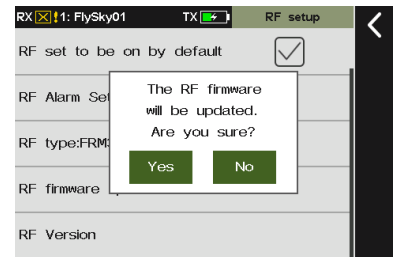

7.22 System

The system menu content is mainly used to set various functions of the transmitter, such as screen settings, sound settings, and so on.

7.22.1 Language

You can choose the appropriate language from English and Chinese.

Function Settings:

1. Enter Language setting menu.
2. Tap an appropriate language, then click  to return.

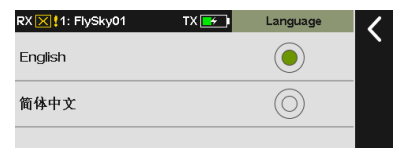

7.22.2 Units

To choose what units to use for length and temperature.

Function Settings:

1. Enter Units setting menu.
2. Tap an appropriate unit, then click  to return.

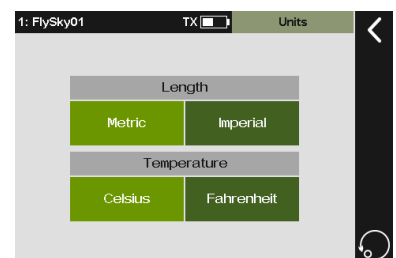

7.22.3 Sound

To turn on or off system sounds, alarm sound, Off/on sound.

Function Settings:

1. Enter Sound setting menu.
2. Tap the sound item, if the ✓ appears, indicating the sound is on, otherwise, the sound is off.
3. Click + / - to change the volume, then click ⏪ to return.

Note: This function is enabled by default. If it is enabled the box will have a check in it, to disable it by clicking it.

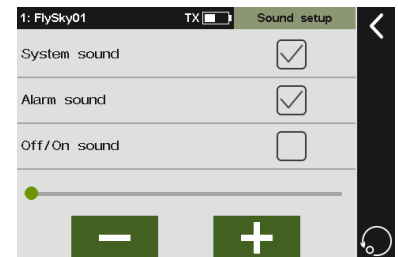

7.22.4 Vibration

This function enables or disables vibration for various actions.

Function Settings:

1. Enter Vibration setting menu.
2. Tap the item you want to set to enter.
3. Tap an appropriate item, then click ⏪ to return.



7.22.5 Backlight Timeout

Changes how long the screen takes to turn off when the transmitter is not in use. The default is 30 seconds. You can set an appropriate time as your desired.

Function Settings:

1. Enter Backlight timeout setting menu.
2. Click + / - to change to an appropriate value, then click ⏪ to return.

Note: Leaving the screen on for longer will use more power and as such may lead to reduced battery time.



微信公众号



Bilibili



Website



Facebook

7.22.6 Backlight Brightness

To adjust the brightness of the screens backlight.

Function Settings:

1. Enter Backlight brightness setting menu.
2. Click + / - to change to an appropriate value, then click  to return.

Note: Turning the brightness up will use more power and as such will lead to reduced battery life.



7.22.7 Standby Timeout

This function can be used to set the idle alarm time of the transmitter. If the transmitter does not bind the receiver and the transmitter does not operate at all, an alarm will be sent within 3 minutes by default. Select "None" to disable this function.

Function Settings:

1. Enter Standby timeout setting menu.
2. Tap an appropriate item, then click  to return.



7.22.8 Auto Shutdown

Turns the transmitter off if not connected to a receiver and is not in use.

This function is enabled by default. To disable the function, tap the box and make sure there is in it.

Function Settings:

1. Enter Auto shutdown setting menu.
2. Tap an appropriate item, then click  to return.

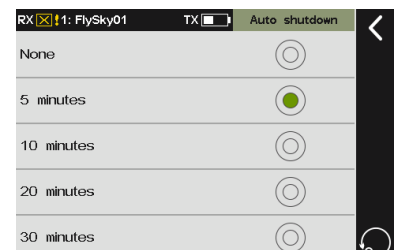

7.22.9 Screen Quick Access

Used to set up the up, down, left and right shortcut screen sliding functions of the mainmenu. Users can customize the screen sliding menu according to their requirements.

Function Settings:

1. Enter Screen quick access setting menu.
2. Tap an appropriate item you want to set to enter.
3. Tap a function, then click  to return.

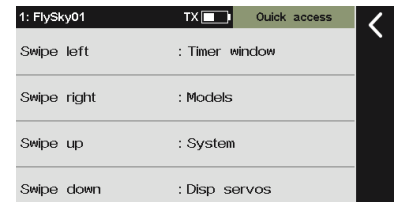

7.22.10 Switch Setting

This function is used to set the level of the shift switch SWE-SWH, and the 2 and 3 levels can be selected.

Function Settings:

1. Enter Switch setting setting menu.
2. Tap the box next to the switch to select 2 levels or 3 levels, then click  to return.

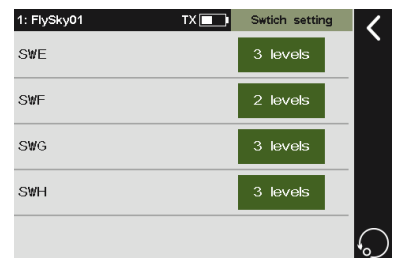

7.22.11 Calibration

Used to calibrate two sticks, three knobs and two shift levers.

Function Settings:

1. Enter Calibration setting menu.
2. According to the prompt in screen, toggle the sticks, knobs or the lever to their Max/Min travel range.
3. Click  to return. After the calibration is successful, click Yes to exit.

Note: If calibration fails, click Yes to exit calibration, and click No to start recalibration.

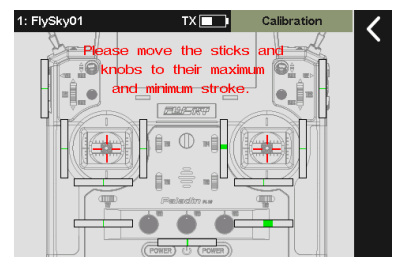

微信公众号



Bilibili



Website



Facebook

7.22.12 Factory Reset

To reset the transmitter to its factory default state. This deletes all data including all model data and system settings.

Function Settings:

Tap Factory reset, a pop-up window comes alone, click Yes to finish.

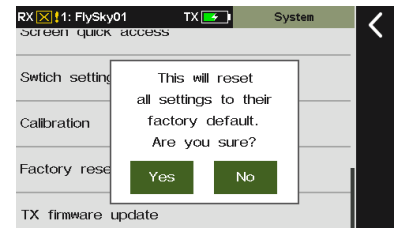

7.22.13 TX Firmware Update

Used to put the transmitter into firmware updating state. In case of updating the firmware of the transmitter, use this function to put the transmitter into updating state first, then upgrade the transmitter's firmware.

Function Settings:

1. Download the latest firmware.
2. Connect the PC and PL18 EV transmitter via micro USB cable, then open the firmware and make sure the transmitter is recognized by PC.
3. At the transmitter side, click TX firmware update. Then touch Yes in the menu comes along to put the transmitter into updating state.
4. At PC side, click Update to start.

Notes:

1. If the transmitter's firmware version is 1.0.20 or 1.0.28, the transmitter's firmware can be updated by TX firmware update function. before updating, to put the transmitter into updating state via this function. You also can put it into updating state via FlySkyAssistant V3.0. If the transmitter's firmware version is 1.0.20, to put the transmitter into updating state first, then upgrade the firmware by FlySkyAssistant. When the transmitter's firmware version is 1.0.28, In such case, make sure the transmitter is connected to the PC only.
2. If more than one firmware are opened at the same time, only one firmware can be recognized by the transmitter.

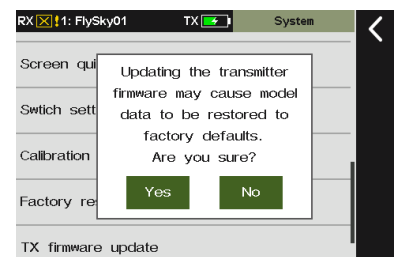

7.22.14 About Paladin EV

To view system information, including product name, software version, software release date, and hardware version.

Function Settings:

Tap About Paladin EV to view.



7.23 Hlep Center

To obtain the user manual via this function. Users can contact us through social accounts listed on the menu.

Function Settings:

1. Tap Help center to its setting menu.
2. Tap the item you want to view, then the corresponding QR code will be displayed.
3. Scan the QR code to obtain the related information. Then click  to return.

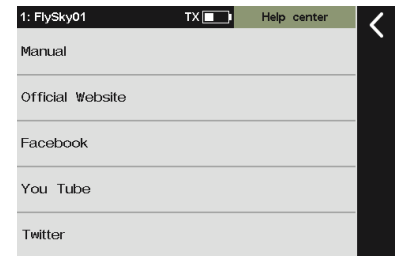

微信公众号



Bilibili



Website



Facebook

8. Product Specifications

This section describes the PL18 EV transmitter, FGr12B receiver, and sensor type receiver.

8.1 Transmitter Specifications (PL18 EV)

Product Model	PL 18 EV
Product Name	Paladin EV
Channels	18
Adaptable receivers	All receivers with AFHDS 3 protocol
Model Type	Engineering vehicles, simulation ships, etc.
RF	2.4GHz ISM
Maximum Power	< 20 dBm (e.i.r.p.) (EU)
2.4GHz Protocol	AFHDS 3
Distance	$\geq 300\text{m}$ (Ground distance without interference)
Channel Resolution	4096
Battery	1S (3.7V) * 4300mAh (Built-in)
Charging Interface	Micro USB/Wireless charging
Charging Time	4h@5V*2A/7h@5V*2A (Wireless charging)
Life time	>5.5h (Standard accessories)
Low Voltage Warning	< 3.65V
Antenna Type	Dual antenna (Built-in)
Display	HVGA 3.5 TFT, 320*480
Language	Chinese and English
Simulator	USB Simulator
Data Interface	USB, Non-standard interface (USART) and PHJACK (PPM)
Temperature Range	-10°C ~ +60°C
Humidity Range	20% ~ 95%
Online Update	Yes
Color	Black
Size	120mm*195mm*213 mm
Weight	1012g
Certification	CE, FCC ID:N4ZFT1800



8.2 Receiver Specifications (FGr12B)

FGr12B

Model Type	FGr12B
PWM Channels	12
RF	2.4GHz ISM
2.4GHz Protocol	AFHDS 3
Distance	≥ 300m (Ground distance without interference)
Antenna Type	Single antenna
Power	3.5 ~ 9V/DC
RSSI	Yes
Data Interface	i-BUS/S.BUS/PPM/PWM
Temperature Range	-10°C ~ +60°C
Humidity Range	20% ~ 95%
Online Update	Yes
Size	37mm*25mm*17.5mm
Weight	11.2g
Certification	CE, FCC ID:N4ZFGR12B



微信公众号



Bilibili



Website



Facebook

9. Package Contents

Number	Name	Quantity	Configuration	Remarks
1	PL18 EV Transmitter	1	Standard	
2	QUICK START GUIDE	1	Standard	
3	FGr12B Receiver	1	Standard	
4	FRM301 RF Module	1	Standard	
5	Thin grip	1	Standard	
6	RF fixed plate	1	Standard	
7	USB	1	Standard	
8	LOGO sticker 1	1	Standard	
9	LOGO sticker 2	1	Standard	
10	Fuselage stickers for PL18 EV	1	Standard	
11	Button switch rubber cover	3	Standard	1 in orange, 1 in yellow, 1 in blue, 3 groups in total
12	i-BUS receiver:FS-CEV04, and i-BUS Sensors: FS-CAT01(Autitude), FS-CPD01(speed/Magnetic sense), FS-CPD02(speed/Light-sensitive), FS-CVT01(Voltage), FS-CTM01(Temperature)	1	Optional	
13	Bracket	1	Optional	
14	JR module adapter	1	Optional	
15	Trainer cable	1	Optional	
16	FGr8B Receiver	1	Standard	For flagship version only. For the standard version, users need to purchase it separately.
17	Wireless charging base	1	Standard	
18	Tray (with hand rest)	1	Standard	
19	Tray strap	1	Standard	



10. Certification

10.1 DoC

Hereby, [Flysky Technology co., ltd] declares that the Radio Equipment [Paladin(PL18 EV),FT18 EV] is in compliance with RED 2014/53/EU.

The full text of the EU DoC is available at the following internet address: www.flysky-cn.com

10.2 CE Warning

The antenna(s) used for this transmitter must be installed to provide a separation distance of at least 20 cm from all persons and must not be co-located or operating in conjunction with any other transmitter. End-users and installers must be provided with antenna installation instructions and transmitter operating conditions for satisfying RF exposure compliance

10.3 Appendix 1 FCC Statement

This equipment has been tested and found to comply with the limits for a Class B digital device pursuant to part 15 of the FCC rules. These limits are designed to provide reasonable protection against harmful interference in a residential installation. This equipment generates, uses and can radiate radio frequency energy and, if not installed and used in accordance with the instructions, may cause harmful interference to radio communications. However, there is no guarantee that interference will not occur in a particular installation. If this equipment does cause harmful interference to radio or television reception, which can be determined by turning the equipment off and on, the user is encouraged to try to correct the interference by one or more of the following measures:

- Reorient or relocate the receiving antenna.
- Increase the separation between the equipment and receiver.
- Connect the equipment into an outlet on a circuit different from that to which the receiver is connected.
- Consult the dealer or an experienced radio/TV technician for help.

To assure continued compliance, any changes or modifications not expressly approved by the party responsible for compliance could void the user's authority to operate this equipment. (Example use only shielded interface cables when connecting to computer or peripheral devices).

This equipment complies with Part 15 of the FCC Rules. Operation is subject to the following two conditions:

- (1) This device may not cause harmful interference.
- (2) This device must accept any interference received, including interference that may cause undesired operation.

Caution!

The manufacturer is not responsible for any radio or TV interference caused by unauthorized modifications to this equipment. Such modifications could void the user authority to operate the equipment.

1. Move all your channels to the desired position.
2. Select [All channels] and then [Yes] in the confirmation box.



微信公众号



Bilibili



Website



Facebook

11. Environmentally friendly disposal

Old electrical appliances must not be disposed of together with the residual waste, but have to be disposed of separately. The disposal at the communal collecting point via private persons is for free. The owner of old appliances is responsible to bring the appliances to these collecting points or to similar collection points. With this little personal effort, you contribute to recycle valuable raw materials and the treatment of toxic substances.



Figures and illustrations in this manual are provided for reference only and may differ from actual product appearance. Product design and specifications may be changed without notice.





<http://www.flysky-cn.com>

Copyright ©2022 Flysky Technology co., ltd

出版日期 :2022-06-01



微信公众号



Bilibili



Website



Facebook



CE, FCC ID:N4ZFT1800

Manufacturer: ShenZhen FLYSKY Technology Co., Ltd

Address: 16F, Huafeng Building, No. 6006 Shennan Road, Futian District, Shenzhen, Guangdong, China